

OPERATING GUIDE



intimus TSI - 2.0/2.5



www.intimus.com

ProSource Packaging, Inc.

14911 Stuebner Airline Rd. Ste. A Phone: (281) 453-8801

Houston, TX 77069 www.machine-solution.com

TABLE OF CONTENTS

1	Health, Safety and Environment	2
1.1	Precautions and Safety Issues	2
1.2	Country Specific Conditions	3
1.3	End of Life	4
2	Functional description	5
2.1	The Folding and Inserting Process	5
2.2	Operating Controls	7
2.3	Control Panel	8
2.4	User Interface Description	8
3	Operating Instructions	11
3.1	Installing the Envelope Catch Tray	11
3.2	Starting Up	11
3.3	Loading Documents	12
3.4	Loading Envelopes	14
3.5	Filling the Sealing Liquid Reservoir	15
3.6	Run a Job	15
3.7	Daily Mail	16
3.8	Stopping the system	16
4	Job Programming	17
4.1	Create a Job	17
4.2	Edit a Job	18
4.3	Delete a Job	18
5	Operator Maintenance	19
5.1	Cleaning or Replacing Moistening Brushes	19
5.2	Clean the System	19
6	Fault finding	20
6.1	Error Messages	20
6.2	Clearing Stoppages	20
6.3	Operator Troubleshooting	22
7	Specifications	27
7.1	Technical Specifications	27
7.2	Dimensions	27
7.3	Other Specifications	27
7.4	Document Specifications	27
7.5	Envelope and Insert Specifications	28
8	Terminology	29
	Index	34

1. HEALTH, SAFETY AND ENVIRONMENT

1.1 Precautions and Safety Issues

Thoroughly read this operator manual, before using this system.

According to the EC declaration (European Commission) following the Low Voltage Directive (2006/95/EC), this operator manual must be available in the national language(s) of the country where the system is delivered. Therefore, if you do not have an operator manual in your country's language(s), contact your authorized distributor.

Warnings

- Disconnect the mains supply before performing any maintenance.
- Before connecting check if the system is suitable for the local mains voltage. Refer to the type plate.

Safety Precautions

- Only competent personnel should operate this system.
If incompetent personnel do operate this system, the manufacturer does not accept responsibility for any resulting accidents or injuries.
- Only skilled persons, who are aware of the risks involved, may open the protective covers.
For safety reasons, the system will not function when the covers are open.
- Keep long hair, fingers, jewelry, etc. away from rotating and moving parts.
- The power connection must be easily accessible, preferably close to the system.
- For safety reasons, it is essential that the system is connected to a socket outlet that has a protective earth connection.
- Over-current protection in the equipment also relies on the branch circuit protection (max. 20 A).
- The following part is considered the equipment disconnect device:
 - Power supply cord plug or appliance coupler

Conventions



Warning

This symbol:

- Identifies situations where improper use of the system can result in personal injury or permanent/catastrophic damage to the system.
- Indicates that the operator manual should be consulted.

Note

A note gives additional relevant information.

Caution

Indicates the presence of a hazard that can cause personal injury or property damage, if the hazard is not avoided.

1.2 Country Specific Conditions

Denmark

In Denmark, certain types of Class 1 appliances may be provided with a plug that does not provide an adequate earth connection when inserted into a Danish socket outlet.

Make sure the system has a good functioning connection that has protective earthing (the plug and socket outlet must match).

Japan

- Establish an earth connection before connecting the mains plug to the power supply.
- First disconnect the power supply before removing the earth connection.

Languages

This manual is also available in other languages. For more information, please contact your local supplier.

1.3 End of Life

The objectives of the European Community's environment policy are, in particular, to preserve, protect and improve the quality of the environment, protect human health and utilise natural resources prudently and rationally. That policy is based on the precautionary principle and principles that preventive action should be taken, that environmental damage should as a priority be rectified at source.

Separate collection of waste is the precondition to ensure reuse and recycling of waste that is generated at the disposal of electrical or electronic equipment and is necessary to achieve the chosen level of protection of human health and the environment in the European Community.

More particularly, certain materials and components of waste electrical and electronic equipment needs selective treatment as their injudicious handling or disposing of on or into land, water or air would represent a major threat to the environment and human health.

In order to facilitate collection and treatment separated from normal domestic waste, electrical and electronic equipment is marked with the following logo:

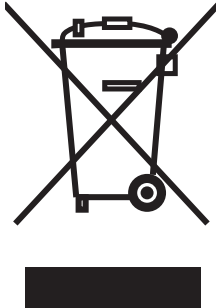

Do not mix with normal domestic waste
Please use the subjoined return or
collection system dedicated to electrical
and electronic waste.

Equipment produced after August 13,
2005.

Not only are you by law not allowed to dispose of the waste equipment via other waste-streams, but we encourage you to actively contribute to the success of such collection and to the common good and better quality of life of present and future generations.

For more information on the correct disposal of this product please contact your local dealer.

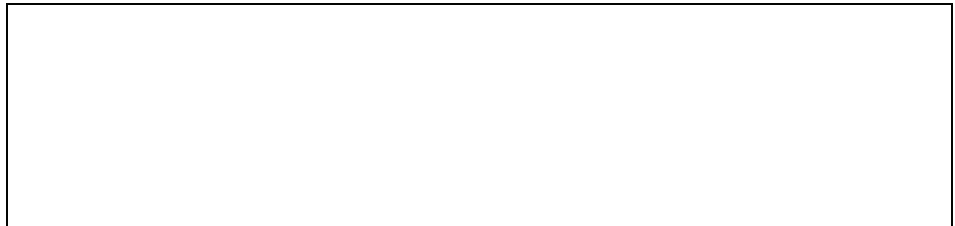

2. FUNCTIONAL DESCRIPTION

The system feeds, folds and inserts documents into envelopes and then seals and stacks the envelopes. Automatic monitoring ensures the correct number of inserts per envelope.

The system is a sophisticated folding and inserting system which can process large quantities of mail rapidly and easily.

You can save the settings of the system (document type, envelope type and fold type) in so-called jobs.

2.1 The Folding and Inserting Process

The figure shows an overview of the document and envelope flow.

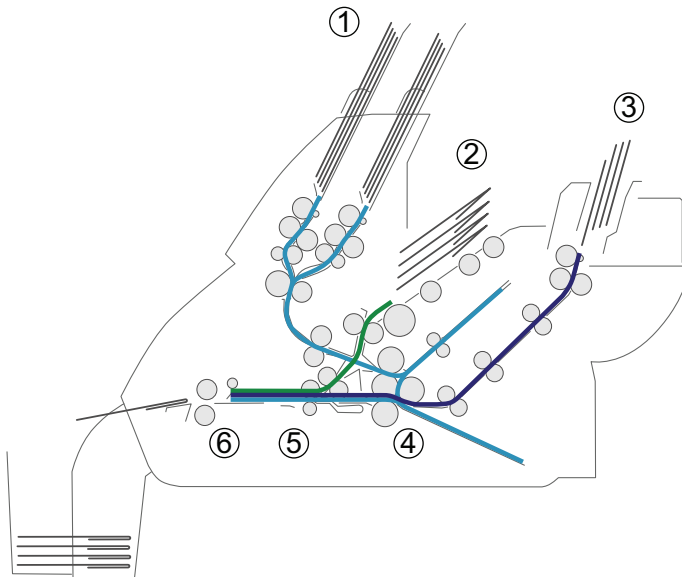

Feeder Area (1)

The system has a feeder block with two document feeders. The feeder block is equipped with hopper swap. This means that you can link both feeders as pairs. When the first feeder is empty, the system switches to the other feeder. Meanwhile you can refill the other empty feeder without stopping the system.

The front feeder (feeder 1) is equipped with a "daily mail" function to process documents or sets of documents which cannot be processed automatically (e.g. stapled).

Double Feed Control (DFC)

Each feeder has double feed control (DFC). In this way the system can detect faulty sets of documents. When a job is started, the first document taken per feeder is used for a reference measurement. When a document is exceeding that reference thickness an error will be displayed.

Note

When Daily mail is selected, the DFC is switched off automatically.

Envelope Hopper (2)

The envelopes are picked up and transported to the insert position inside the system.

Feeder for Business Reply Envelopes (BRE) and Other Enclosures (feeder 3)

Small enclosures or BREs are fed from feeder 3 and added to the folded document set.

Folding area (4)

In the folding area the documents are folded. The following fold types are possible (see "Terminology" on page 29):

- No fold
- V-fold (single fold)
- C-fold (letter fold)
- Double V-fold (double parallel fold)

Inserter (5)

The folded document set is transported to the inserter unit and inserted into a waiting envelope. The inserter can seal the envelope.

Exit (6)

The mail set leaves the system from the exit.

2.2 Operating Controls

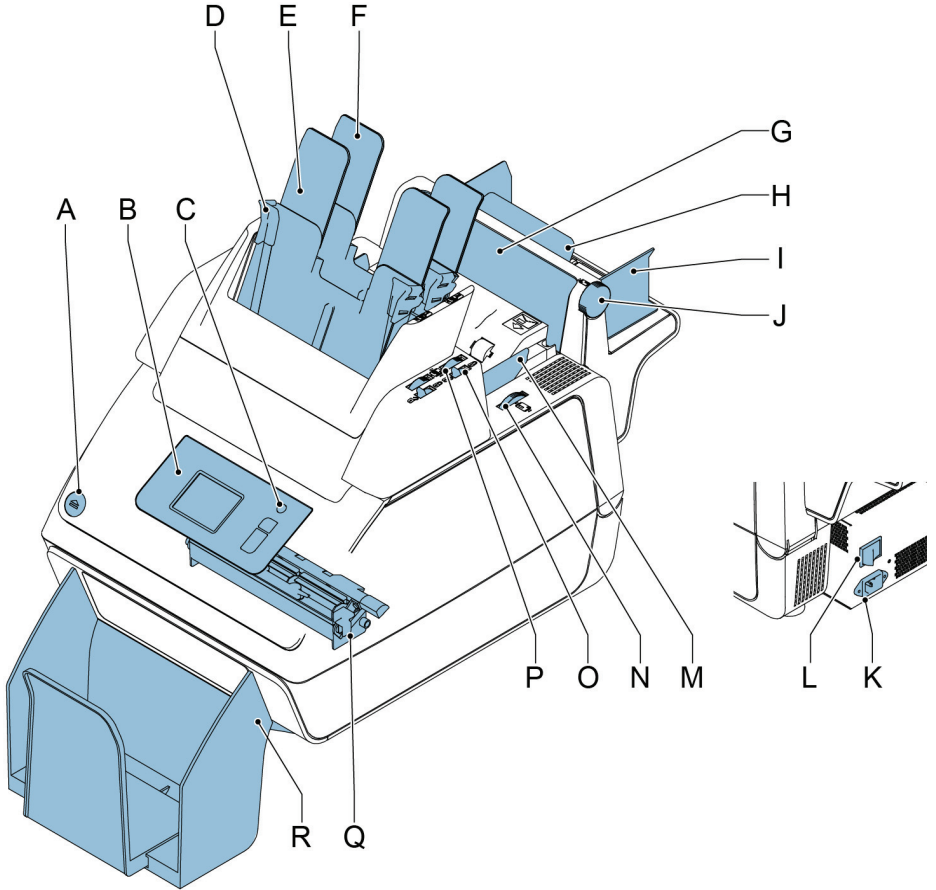



- | | | | |
|---|---|---|--|
| A | button to open the system | K | power inlet |
| B | control panel with touch screen | L | power switch |
| C | standby button | M | side guides envelope hopper |
| D | paper guides | N | thumb wheel for adjusting side guides envelope hopper |
| E | document feeder 1 | O | locking lever for side guides of document feeder tray 2 and for filling tray 2 |
| F | document feeder 2 | P | thumb wheel for adjusting side guides document feeder tray 2 |
| G | flap, for access to document path of feeder 3 | Q | sealing liquid reservoir |
| H | support feeder 3 | R | catch tray |
| I | side guides feeder 3 | | |
| J | thumb wheel to adjust side guides feeder 3 | | |

2.3 Control Panel

The system has a touch screen (**D**).

There are three buttons next to the touch screen:

- Standby button **A** to switch the system on or off.
- : the stop key (**B**)
When the stop key is pressed, the system completes the current set and stops.
- : the start key (**C**)
When the start key is pressed the system starts processing.

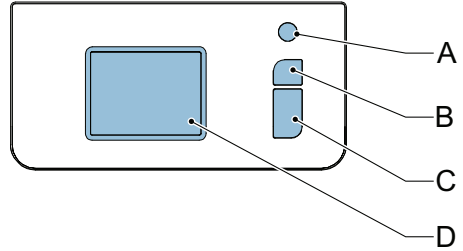









Caution

The touch screen is covered with a thin pressure-sensitive layer. To avoid permanent damage of the touch screen, do not use sharp objects to press on the touch screen.

2.4 User Interface Description





2.4.1 Explanation of Buttons and icons

Buttons

	Opens a selection menu with language settings and supervisor menu		Back: return to the previous menu
	Home: return to the 'job selection' menu		Save: save changes to a job
	New job: create a new job		OK or Yes: confirm choice
	Edit: open the 'job settings' menu		No: reject choice

Meaning of Icons in Upper Left Corner of Touch Screen

The icons in the upper left corner indicate the menu type you are working in.

	Home menu or 'job selection' menu		Settings
	'job settings' menu		Wizard

2.4.2 Home (Job Selection)

When you start up the system, the home menu 'job selection' appears. With the arrows you can scroll through the jobs. If you want more information on a job, select the job (see 2.4.3 "Job Description (Current Job)" on page 9).

The **Menu** button opens a selection menu (see 2.4.4 "Menu" on page 10).

With the **New Job** button you can define a new job (see "Create a Job" on page 17).

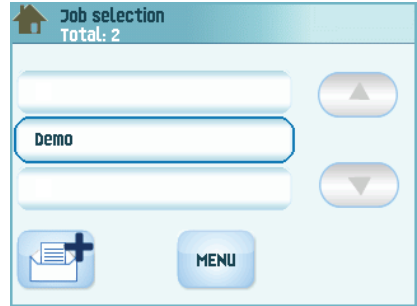

2.4.3 Job Description (Current Job)

If you want more information on a job, select the job in the 'job selection' menu.

The 'current job' menu shows the following information of the selected job:

- Job name.
- Job counter: total number of mail sets that have been processed with this job.

If you want to set the job counter to zero, press the edit button  and **Reset job counter**.

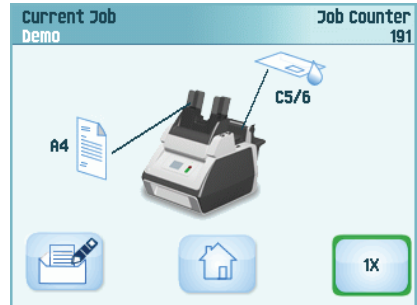

Note

The counter settings are job related.

- A picture of the system with symbols for the selected features. The following symbols can be used:



Feeder 1 is set for daily mail.



Sealing is on.

With the home button  you get back to the home menu ('job selection').

2.4.4 Menu

When you press the **Menu** button a selection menu appears. This menu allows you to change system settings and define jobs. The screen shows the following functions:

- **Language settings:** change the language of the user interface.
- **Supervisor menu:** define envelope settings (see "Supervisor Menu" on page 10, only for authorized personnel).

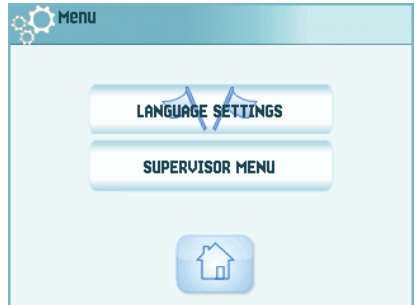

2.4.5 Supervisor Menu

When you press the **Supervisor menu** button in the selection menu, a login menu opens. Enter the PIN-code **2546** to access the 'supervisor menu'.

When you enter the correct pin code the 'supervisor menu' appears. This menu enables you to:

- Define custom envelope sizes (press the **Adjust stop position** button).
- Adjust the envelope stop position (see "Envelope Position" on page 26).
- Adjust the sealing position (see "Sealing position" on page 26).
- Switch off popups, like the popup that tells you to press the 1x button.



2.4.6 Job Settings Menu

When you press on a job and press the edit button , the 'job settings' menu opens. This menu enables you to:

- Edit a job (see 4.2 "Edit a Job" on page 18).
- Delete a job (see 4.3 "Delete a Job" on page 18).
- Reset the job counter: sets counter to zero.
- Switch the double feed control (DFC) on or off, per feeder. For example, if you have a document with an address sticker on it, switch the DFC off. The DFC sees the sticker as a double feed and generates an error message.

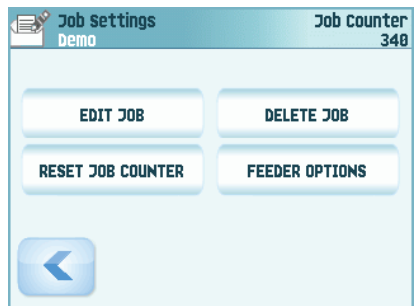

3. OPERATING INSTRUCTIONS

3.1 Installing the Envelope Catch Tray

To install the envelope catch tray:

1. Move the catch tray until the clamps hold the feet of the system.
2. Adjust the catch tray to the correct envelope size.

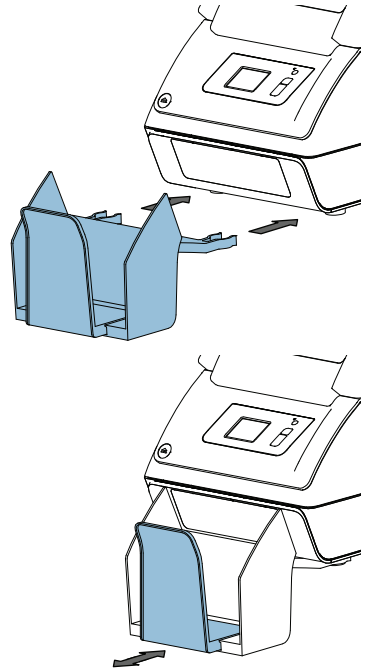

3.2 Starting Up

Warning

You can severely damage the system if it is connected to the incorrect power supply. Before plugging in the system, check if the local voltage is the same as the voltage mentioned on the type plate.

For the location of switches and buttons, see "Operating Controls" on page 7.

To start up the system:



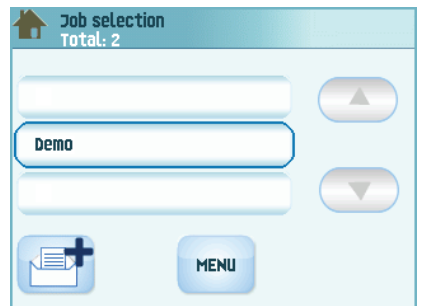







1. Connect the system to the mains power supply.
2. Use the power switch to switch the system on. The power switch is located at the back of the system.
3. Press the power button next to the display. The touch screen shows the home menu.

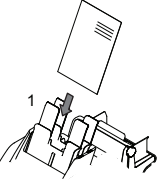
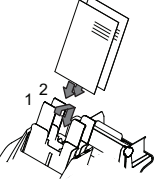
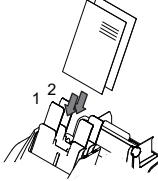
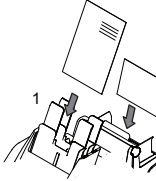

3.3 Loading Documents

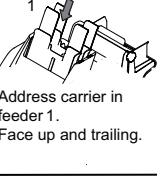
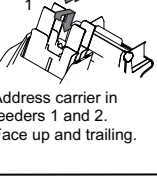
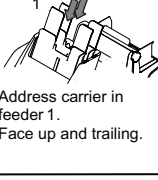
3.3.1 Document Orientation

See also the job information on the touch screen. The table shows how to load documents, depending on the fold type.

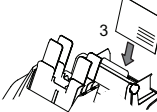
		 one document	 feeder linking	 two documents	 document + enclosure
V-fold					
C-fold					
double V-fold		Address carrier in feeder 1. Face up and trailing.	Address carrier in feeders 1 and 2. Face up and trailing.	Address carrier in feeder 1. Face up and trailing.	Address carrier in feeder 1. Face up and trailing.
no fold					
		Address carrier in feeder 3. Face up and trailing.			

3.3.2 Adjusting the Side Guides of the Document Feeder

To adjust the side guides of the document feeder trays:

1. Pull lever **C**.
2. Move the side guides **A** apart as far as possible with thumb wheel **B**.
3. Put a small stack of documents between the side guides.
4. Move the side guides towards the documents with thumb wheel **B**.

The space between the side guides and the documents should be such that the documents have just enough play to move freely.

5. Return lever **C** to its original position.
6. Remove the stack of documents.

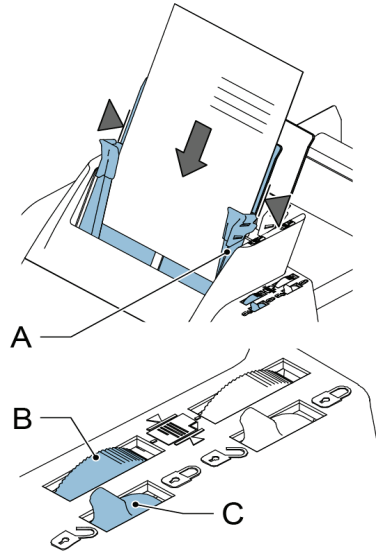

3.3.3 Loading the Document Feeder Tray

To load the document feeder tray:

1. Pull lever **C** at the tray.
2. Place a stack of documents between the side guides.

Feed the documents (depending on the type of documents) as shown in 3.3.1 "Document Orientation" on page 12.

3. Return lever **C** to its original position.

3.3.4 Adjusting the Side Guides of Feeder 3

To adjust the side guides of feeder 3:

1. Move the side guides **C** apart as far as possible with thumb wheel **D**.
2. Pull back support **B**.
3. Put a small stack of enclosures (**A**) between the side guides.
4. Release support **B**.
5. Move the side guides towards the enclosures with thumb wheel **D**.

The space between the side guides and the enclosures should be such that the enclosures have just enough play to move freely.

6. Remove the stack of enclosures.

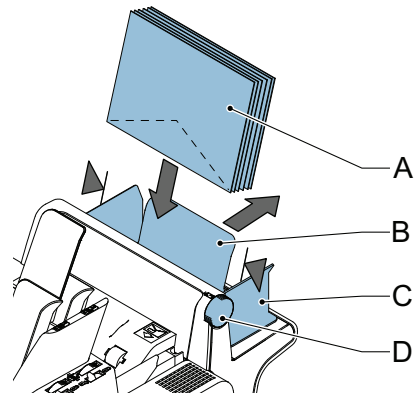

3.3.5 Loading Feeder 3

To load feeder 3:

1. Pull back support **B**.
2. Place a stack of documents or BREs between the side guides.
Place documents with trailing edge down. Place BREs with leading edge down and the flap at the support side.
3. Release support **B**.

3.4 Loading Envelopes

To load the envelopes:

1. Move the side guides **B** apart as far as possible with thumb wheel **A**.
2. Fan the stack of envelopes **C** and place them between the side guides (flap down and trailing - bottom side of envelope pointing to the system).
3. Move the side guides towards the envelopes with thumb wheel **A**.

The space between the side guides and the envelopes should be such that the envelopes have just enough play to move freely.

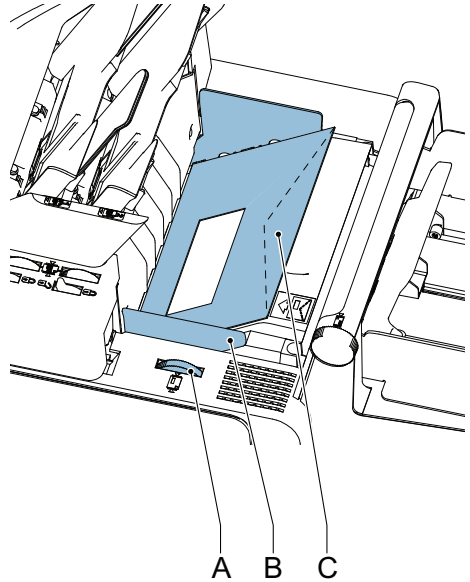

Note

If the distance between the side guides is too large, the envelopes will skew, when transported into the system.

3.5 Filling the Sealing Liquid Reservoir

When you want to seal envelopes, the sealing liquid reservoir must be filled.

1. Press the  button to open the system (see "Operating Controls" on page 7).
2. Lift the sealing liquid reservoir **D** with the blue handles **A** carefully out of the system.
3. Remove the strip **C** from the reservoir.
4. Fill the three reservoirs with sealing liquid.
5. Make sure the brushes **B** are moistened sufficiently.
6. Replace the liquid reservoir.
7. Close the system.

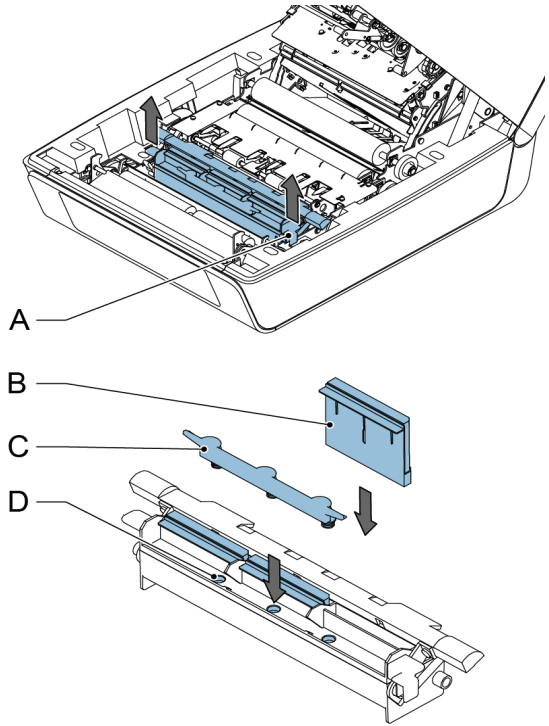

Before you start the job, wait approximately 5 minutes for the brushes to moisten.

3.6 Run a Job

Note

Before you run a job, make sure the sealing liquid reservoir is filled.

To run a job:

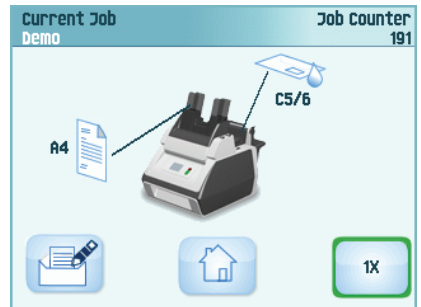

1. From the home menu choose a job.
The job information appears (see "Job Description (Current Job)" on page 9).
2. Load envelopes as specified in the job.
3. Load the documents face up and trailing, as specified in the job.
Place the address carrier in feeder 1.
4. Press the **1x** button to start a test run or press the  button to start the job.



If you press the **1x** test button, the system helps you to adjust the address position (see 6.3.7 "Address Position" on page 26).

3.7 Daily Mail

To process documents or sets of documents, which can not be processed automatically (e.g. stapled documents), you can use feeder 1 as a daily mail feeder. Daily mail can handle sets with a maximum of five sheets (80 g/m²).

1. To use the daily mail function, define a new job with daily mail (see "Job Programming" on page 17) or use an existing daily mail job.
2. Place the document or document set in the feeder 1.
3. Press the  button to start the job.
The document or document set will be folded and inserted into the envelope as defined in the selected job.
4. Place the next document or document set in the feeder. The system will keep running to process the inserted document or document set.
5. When finished with Daily Mail, press the  button to stop the job.

3.8 Stopping the system

To stop the system press the  button. The system completes and inserts the current set and stops. This results in a cleared system which is ready to process a new job.

4. JOB PROGRAMMING

4.1 Create a Job

To create a new job:



1. In the home menu, press the  (new job) button.

The Job Wizard starts and helps you to choose:

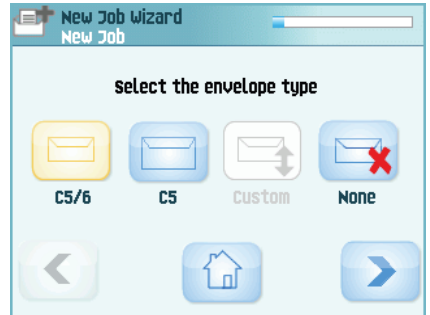
- Envelope size. Custom is only available if defined by the supervisor ("Supervisor Menu" on page 10).
- If the envelopes should be sealed or not.
- Document size for feeder 1.
- Daily mail or normal documents.
- Document size for feeder 2. If you choose None, you can use feeder 2 as a linked feeder. This means that when one feeder is empty, the system automatically starts picking documents from the other feeder.
- Enclosure size (from feeder 3).
- Fold type.



2. Press the **1x** button to make sure that the address position is correct (see "Address Position" on page 26).

3. Press the  button to start the job or press the  button to save the job.

4. If you press the  button:
 - a Enter a name for the job. Use the **<** button to clear a character left of the cursor position (backspace).
 - b Press the **>** button to confirm the job name.

4.2 Edit a Job

To edit an existing job:

1. From the home menu choose a job.
2. Press the edit button .
The 'job settings' menu opens.
3. Press **Edit job**.
The Job Wizard starts and helps you to change job settings.
4. Press **Save** to save the job with the changed settings.
5. Press the **1x** button to make sure that the address position is correct (see "Address Position" on page 26).

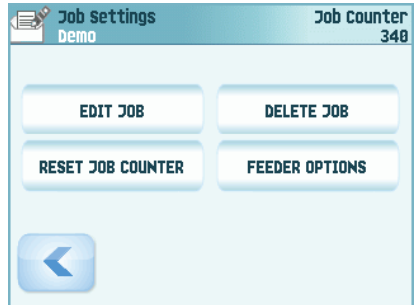

4.3 Delete a Job

To delete an existing job:

1. From the home menu choose a job.
2. Press the edit button .
The 'job settings' menu opens.
3. Press **Delete job**.
4. Press the **Yes** button to confirm.
The job will be deleted without a warning.

5. OPERATOR MAINTENANCE

Warning

- Disconnect the mains power supply before performing any maintenance.



The user must not attempt to service the system beyond that described in this operator manual. All other servicing must be carried out by qualified service personnel only.

Please contact your authorized distributor.

Maintenance frequency	Maintenance
Daily	<ul style="list-style-type: none">• Check the system functions.• Keep the system in proper condition by removing dust, paper remains, etc.• When dirty, clean the sealing table and rollers with a slightly wetted cloth, soaked in warm water.
Weekly	<ul style="list-style-type: none">• When dirty or saturated, clean the brushes of the envelope sealing (see "Cleaning or Replacing Moistening Brushes" on page 19).• Clean rollers (see "Clean the System" on page 19).

5.1 Cleaning or Replacing Moistening Brushes

See "Filling the Sealing Liquid Reservoir" on page 15 for the location of the brushes.

1. Open the system.
2. Lift the sealing liquid reservoir with the blue handles carefully out of the system.
3. Remove the three brushes.
4. Clean the brushes with a small amount of water.
If the brushes are worn, replace them with new ones.
5. Install the brushes.
6. Fill the tray with sealing liquid.
7. Make sure the brushes are moistened sufficiently.
8. Replace the liquid reservoir.
9. Close the system.

5.2 Clean the System

1. Open the system.
2. Clean the rollers. Use a cleaning product recommended by your authorized distributor and apply it with a lint-free cloth. Wipe each rubber roller while turning it manually.
3. Clean the casing of the system with a damp cloth and a slightly soapy solution.

6. FAULT FINDING

6.1 Error Messages

When an error occurs the touch screen shows a menu showing the following information:

- An indication of the area in which the error occurred.
- An error description.
- A suggested solution.

Special Errors

- Technical errors.

The touch screen shows a message. The error cannot be solved by operating personnel and assistance of the service support is needed.

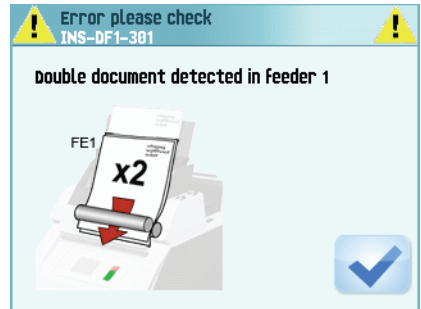

Warning Screen

When a cover is opened, the touch screen shows a warning screen with the message "Cover open" and a suggested solution "Close cover".

6.2 Clearing Stoppages

Stoppages can occur in the following area's:

- Document feeders.
- Document path.
- BRE feeder.
- Envelope feeder.

6.2.1 Document Feeders

When a stoppage occurs in the document feeders, remove the documents as follows:

1. Pull the feeder block forward (see figure).
2. If necessary lift the feeder block out of the system.
3. Remove the documents from the bottom of the feeders.
4. Return the feeder block into the system.

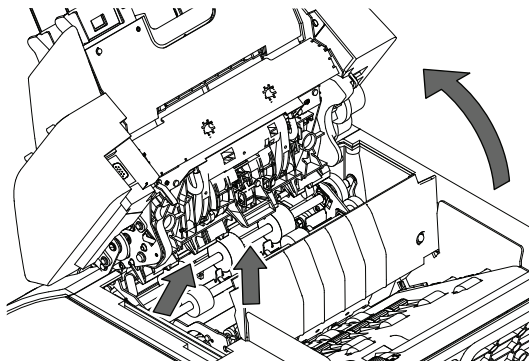

6.2.2 Document Path

When a stoppage occurs somewhere in the document path, remove the documents as follows:

1. Press the  button to open the system.
2. If necessary lift flap **A**, or rotate **B** or roller **E** to transport the document.
3. Remove the documents.
4. Close the system.

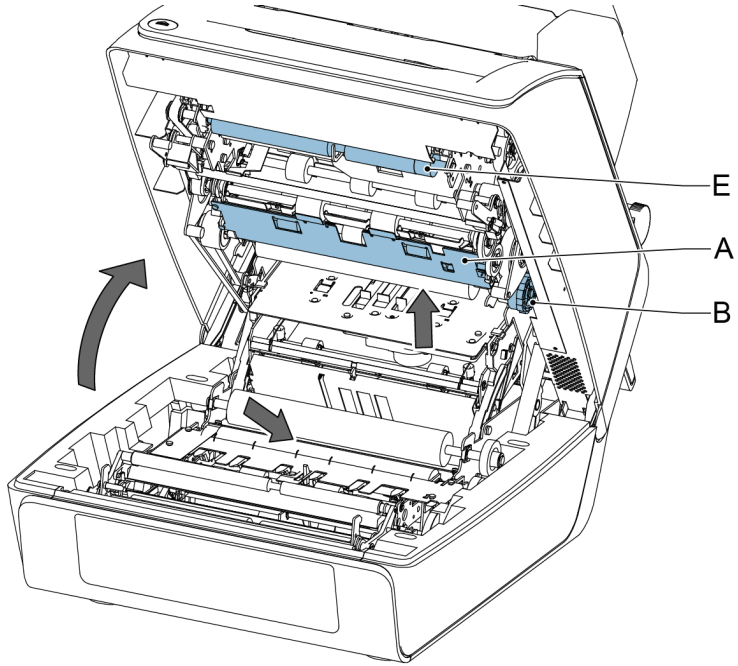

6.2.3 Feeder 3

When a stoppage occurs in feeder 3, remove the document or envelope as follows:

1. Press flap **A** of feeder 3 and rotate the feeder downward.
2. Remove the document or envelope.
3. Close the feeder.

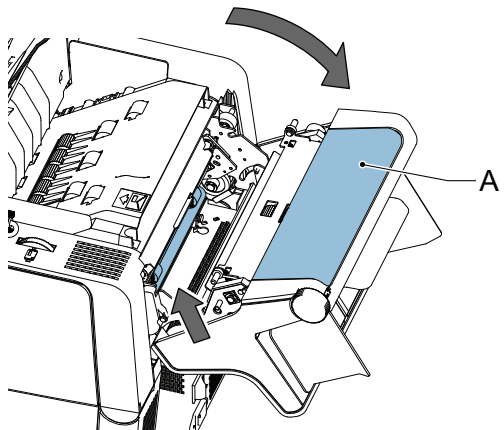

6.2.4 Envelope Hopper

When a stoppage occurs in the envelope hopper, remove the envelopes as follows:

1. Press the  button to open the system.
2. Remove the envelope.

If this is not possible, try to remove it from the top of the hopper:

1. Close the system.
2. Remove the envelope stack and remove the envelope.

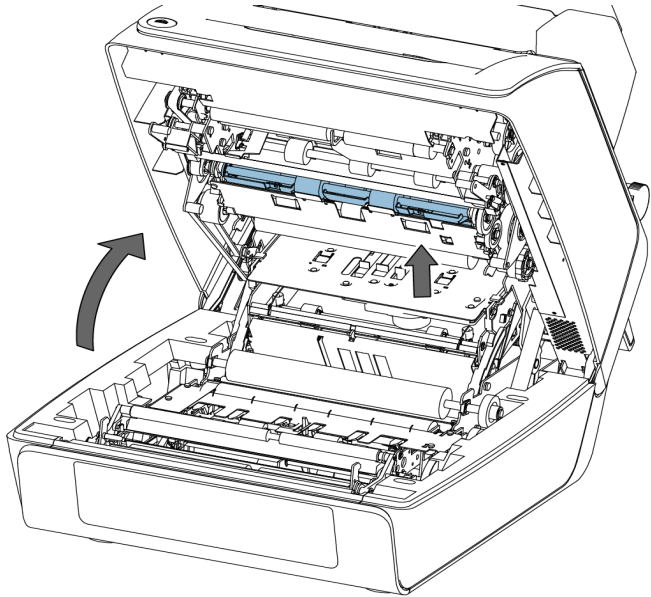

6.3 Operator Troubleshooting

To solve problems:

1. Write down the error.
2. Consult the troubleshooting tables in sections 6.3.1 up to 6.3.5 to solve the problem.
3. Switch the system off and on again, to verify system operation.
4. When the error still occurs contact your service organization.

Note

When contacting the service organization, you will also be asked for the last error message.

6.3.1 Startup Problems

Symptom	Possible cause	Remedy	Reference
The system cannot be started after switching on.	System not connected to mains.	Connect the system to the mains.	-
	You switched off the system accidentally.	Switch the system on.	-
	You did not press the power button next to the touch screen.	Press the power button next to the touch screen.	-
	A cover is opened.	Close the covers.	-

6.3.2 Envelope Sealing Problems

Symptom	Possible cause	Remedy	Reference
Envelope not closed properly.	Insufficient moistening.		See symptom "Flap not sufficiently moistened." on page 23.
	The current job has no envelope sealing.	Make sure if the job is programmed to seal envelopes.	"Job Programming" on page 17
	Document or enclosure not compliant with job specification.	Make sure the document size and enclosure size equals the job settings.	
	Documents are not correctly inserted.	Make sure the side guides of the document feeders are in the correct position.	"Adjusting the Side Guides of the Document Feeder" on page 13
Check envelope stop position, adjust if needed.		"Envelope Position" on page 26	
Envelope contents is wet.	Sealing position is not correctly set.	In the supervisor menu change the settings of the applicable envelope.	"Sealing position" on page 26
	Exit roller is wet.	Clean the exit roller.	"Clean the System" on page 19
Flap not sufficiently moistened.	Water level low.	Check water level, refill if needed.	"Filling the Sealing Liquid Reservoir" on page 15
	Brushes dry.	Check brushes, replace if needed by the extra soaked set.	"Operator Maintenance" on page 19
	Brushes dirty.	Check brushes, clean if needed.	"Operator Maintenance" on page 19
	Brushes worn out.	Replace brushes.	"Operator Maintenance" on page 19
	The current job has no envelope sealing.	Choose job with envelope sealing.	
	Envelope does not meet the specifications.	Make sure the envelope meets the specifications.	"Envelope and Insert Specifications" on page 28
	Poor envelope quality.	Seal an envelope manually to test the adhesion quality.	
	Sealing position is not correctly set.	In the supervisor menu change the envelope settings.	

6.3.3 Envelope feeding problems

Symptom	Possible cause	Remedy	Reference
Envelopes are double fed.	Envelopes not placed properly in the hopper.	Check and replace if needed.	"Loading Envelopes" on page 14
Envelope stops skewed.	Side guides of the envelope hopper are set too wide.	Check side guides and adjust if needed.	"Loading Envelopes" on page 14
Envelopes are fed irregularly.	Hopper almost empty.	Refill hopper.	"Loading Envelopes" on page 14
	Side guides set too narrow.	Check side guides and adjust if needed.	"Loading Envelopes" on page 14
Flap is wrinkled and sometimes not opened.	Envelope not within specifications.	Check specifications and change envelopes if needed.	"Envelope and Insert Specifications" on page 28
	Flap sticks.	Store envelopes according to specifications.	"Envelope and Insert Specifications" on page 28
	Flap curled.	Envelopes stored or manufactured improperly.	"Envelope and Insert Specifications" on page 28

6.3.4 Document feeding problems

Symptom	Possible cause	Remedy	Reference
No document fed.	Feeder empty.	Refill feeder.	"Loading the Document Feeder Tray" on page 13
	Side guides set too narrow.	Adjust the side guides.	"Adjusting the Side Guides of the Document Feeder" on page 13
	Feeder trays are not locked.	Push the lever to lock the feeder.	"Loading Documents" on page 12
Skewed documents fed.	Side guides set too wide.	Adjust side guides.	"Adjusting the Side Guides of the Document Feeder" on page 13
	Feeder trays are not locked.	Push the lever to lock the feeder.	"Loading Documents" on page 12
Shifted documents in feeder trays.	Side guides set too narrow.	Adjust the side guides.	"Adjusting the Side Guides of the Document Feeder" on page 13
	Feeder trays are not locked.	Push the lever to lock the feeder.	"Loading Documents" on page 12
	Dirty feeder rollers.	Clean the feeder rollers.	

Symptom	Possible cause	Remedy	Reference
Double documents are fed, but the system does not notice.	Different types of documents fed.	Use daily mail to process different document types.	
	Documents out of specification.	Check document specifications.	"Document Specifications" on page 27

6.3.5 Insert problems

Symptom	Possible cause	Remedy	Reference
System stops with envelope at insert position (flap not open).	Envelopes stacked reversed in the hopper.	Check envelope feed adjustments. Place envelopes correctly in hopper.	"Loading Envelopes" on page 14
	Envelope flap sticks.	Store envelopes according to specifications.	"Envelope and Insert Specifications" on page 28
	Wrong envelope type used (not according to specifications or job settings).	Change envelopes according to specifications.	"Envelope and Insert Specifications" on page 28
Fingers are placed on top of the envelope.	Envelope stops too early.	Check envelope stop position, adjust if needed.	"Envelope Position" on page 26
System stops while inserting (stoppage at the inserting point).	Inserted document too long or not correctly folded.	Make sure the document size and enclosure size equals the job settings.	
	Envelope throat incorrect.	Check envelope specifications.	"Envelope and Insert Specifications" on page 28
	Envelope glued inside.	Eliminate faulty envelopes.	-
	Window not glued properly.	Eliminate faulty envelopes.	-
Envelope not always ejected from sealer.	Inserted document too big.	Make sure the document size and enclosure size equals the job settings.	
	Document not inserted deep enough.	Check adjustment of envelope stop position.	"Envelope Position" on page 26
	Sealing area dirty.	Clean sealing area.	"Operator Maintenance" on page 19
Address not readable from window	Address position not correctly defined.	Check address position.	"Address Position" on page 26

6.3.6 Envelope Position

To make a good insert of the document set into the envelope, the envelope should be positioned correctly.

To verify the envelope position:

1. Go to the supervisor menu.
2. Press **Adjust stop position**.
3. Choose the envelope type and press the arrow button.
4. Press the **1x** button. Make sure that the document set is completely inserted into the envelope.
5. If not, use the arrow buttons to adjust the envelope position.
6. Repeat step 3 and 4 until the envelope position is correct.
7. Press the  button.

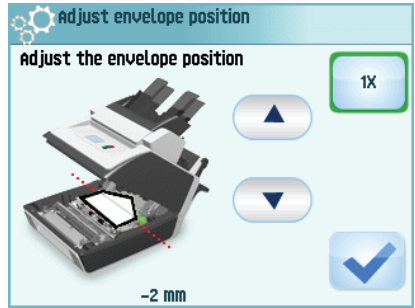

6.3.7 Address Position

The address on the document set should be positioned in a way that you can read it from the envelope window. If it is not readable, adjust the address position as follows:

1. Choose a job and press the **1x** button.
2. Press the **No** button if asked if the address is visible.
3. Use the arrow buttons to adjust the address position.
4. Press the **1x** button again to verify the new position.
5. Press the **Yes** button if the position is correct.

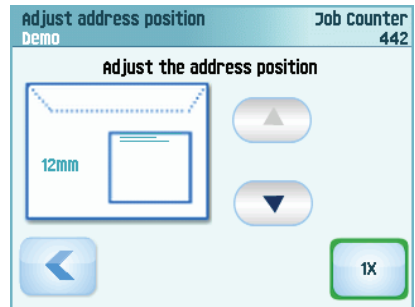

6.3.8 Sealing position

If the sealing area of the envelope is not correctly moistened, adjust the sealing position as follows:

1. Go to the supervisor menu.
2. Press **Adjust moistening position**.
3. Choose the envelope type and press the arrow button.
4. Use the arrow buttons to adjust the sealing position.
5. Press the **1x** button to test the new position.
6. Press the  button if the position is correct.

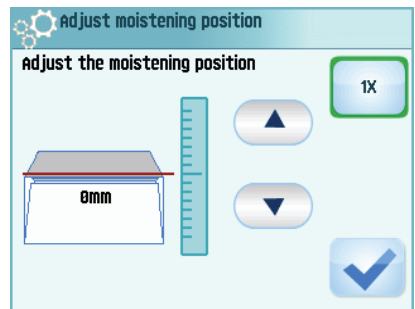

7. SPECIFICATIONS

7.1 Technical Specifications

Model	TSI 2.0/2.5
Type	Fold and insert system for small office use
Theoretical max. speed	1350 inserts per hour, depending on application
Power consumption	100-240 VAC/ 50-60 Hz /Maximum 3 A
Voltage tolerance	100-240 VAC: +6%/-10% 230 VAC: +10%/-10%
Approvals	EMC Certificate conform EMC-Directive FCC Certificate conform 47CFR, part 15 CB Certificate conform IEC 60950-1 UL Listed I.T.E. (Information Technology Equipment), conform UL-IEC 60950-1, file E153801 Conform NEN-EN-IEC 60950-1 and derivatives

7.2 Dimensions

Height	560 mm (22.0 inch)
Width	430 mm (16.9 inch)
Length	660 mm (26.0 inch) without catch tray
Weight	36 kg (79.3 lb)

7.3 Other Specifications

Noise level	< 69 dBA (according to ISO 11202)
Operating temperature	17°C - 34°C (62.6°F - 93.2°F)
Humidity	20%-90%

7.4 Document Specifications

Paper quality	minimum 70 g/m ² (17.5 lb bond) maximum 120 g/m ² (30 lb bond)
Paper size	Minimum width: 142 mm (5.6") Maximum width: 225 mm (8.9") Minimum length: 90 mm (3.5") Maximum length: 356 mm (14.0")
Folding capacity	V-fold - 5 sheets (80 g/m ²) C-fold - 3 sheets (80 g/m ²) Double V-fold - 2 sheets (80 g/m ²)
Enclosure sizes	Standard BRE (Business Reply Envelopes) Maximum length: 158 mm (6.22")

Enclosure quality

BRE, minimum: 75 g/m² (18.75 lb bond)
 BRE, maximum: 120 g/m² (30 lb bond)
 Insert, minimum: 75 g/m² (18.75 lb bond)
 Insert, maximum: 250 g/m² (62.5 lb bond)

7.5 Envelope and Insert Specifications**Envelope quality**

Minimum: 75 g/m² (18.75 lb bond)
 Maximum: 120 g/m² (30 lb bond)

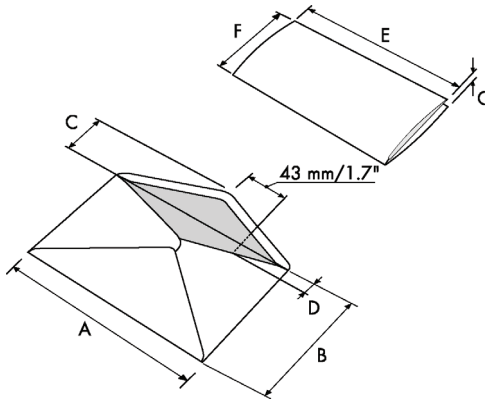

		A	B	C	D	E	F	G
Minimum size	mm	229	105	32	10	142	90*	70 g/m ²
	inches	9.0	4.1	1.25	0.40	5.6	3.5	
Maximum size	mm	241	162	54	35	A-12**	B-6	1.5
	inches	9.5	6.4	2.1	1.4	A-0.47**	B-0.24	0.06
* In case of fold only (no insert): height > 120 mm / 4.7								
** When insert is more than 1 mm (0.04 inch): A-15 mm / A-0.6 inch								

Remarks:

- Maximum insert specifications are based on single sheets. When multiples are handled, more room inside the envelope is needed depending on the application.
- The specification of the paper handling equipment is often wider than that of the envelopes and documents handled. The condition of material handled will limit the specified environmental conditions.
- We recommend that materials to be handled are stored at a temperature of 20°C (68°F) with a relative humidity factor of 50%. If difference in temperature occurs between store room and mailing area, the material has to be stored near the system at least 24 hours before use.
- Self-copying paper may cause rubber parts to wear quicker. The rubber used in this system has the best resistance to Wiggins Teape material.

8. TERMINOLOGY

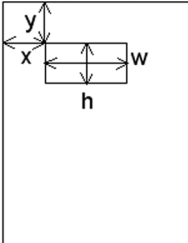
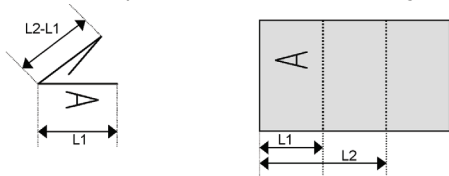
Term	Description
Address carrier	The address carrier is the document that carries the address of the person for who the mail set is meant. The address carrier can consist of one or more sheets, from which at least the first sheet must contain the address. The address must remain visible while enclosures are added and the document set is folded. The fold type and selected envelope must ensure that the address is visible behind the window in the envelope. For personalized mailings there is always an address carrier present as long as envelope printing is not supported. Normally there is one address carrier.
Address position	 <p>Position of the address on the address carrier, measured from the upper left corner. The address position consists of a horizontal x coordinate, a vertical y coordinate, a horizontal width w and a vertical height h.</p>
Business Reply Envelope (BRE)	Envelope included in outgoing mail sets for addressee response purposes.
C-fold	<p>Fold type in which a document set is folded twice in which the folded flaps are on top of each other. This fold is illustrated in the picture below. The position of both folds is adjustable.</p>  <p>sideview</p> <p>Synonym: letter fold.</p>
Daily Mail	Capability of an inserting system to manually insert mail sets one by one into the system, which are then inserted into an envelope. Optionally, depending on settings, additional enclosures can be added and the mail set can be folded. This function is intended for small amounts of mail that each can have a different build-up.
Document	A document is one of the components of a mail set. A document can consist of one or more sheets. Documents can be divided into address carriers and enclosures. For personalized mailings there is always one address carrier and an optional number of enclosures.

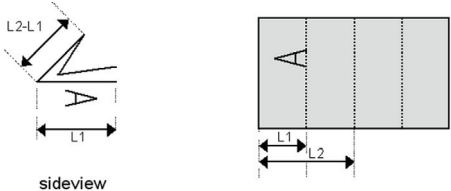
Term	Description
Document set	The document set is the physical collection of address carrier and enclosure(s) that is under production in the inserting system. The document set is completed during production and is to be inserted into the envelope. The number of enclosures can range from 0 to the limit opposed by the number of available feeders. Once the document set has been inserted into an envelope it is called mail set.
Double Feed Control (DFC)	Double Feed Control is the sensor that measures the thickness of a sheet to check if the inserting system does not accidentally take more sheets than intended. DFC sensors exist on feeders (double sheet detection). Currently DFCs on intimus inserting systems perform relative measurements, which means that they need a cycle to 'learn' the thickness of a sheet. Also the length of the document is measured so partly overlapping sheets will be detected.
Double V-fold	<p>The double V-fold is a type of fold where the document is first folded halfway and the resulting folded set is again folded halfway. This fold is illustrated in the picture below. The position of both folds is adjustable.</p>  <p style="text-align: center;">sideview</p> <p>Synonym: double parallel fold.</p>
Envelope	The envelope is the packaging of a mail set. Window envelopes are envelopes that have a transparent section through which the address on the address carrier can be read. Besides the normal top closing window envelopes there are also bottom closing envelopes.
Face down	Situation in which the front of a sheet is facing downwards when placed in a document feeder.
Face down leading	Situation in which the front of a sheet is facing downwards and the top of the sheet is closest to the separation unit in a document feeder.
Face down trailing	Situation in which the front of a sheet is facing downwards and the bottom of the sheet is closest to the separation unit in a document feeder.
Face up	Situation in which the front of a sheet is facing upwards when placed in a document feeder.
Face up leading	Situation in which the front of a sheet is facing upwards and the top of the sheet is closest to the separation unit in a document feeder.
Face up trailing	Situation in which the front of a sheet is facing upwards and the bottom of the sheet is closest to the separation unit in a document feeder.
Feeder	A feeder is a module for the input of documents to the inserting system. The feeder separates documents sheet by sheet from the stack of documents in the feeder tray.

Term	Description
Feeder linking	The ability to load two feeders with the same document type where the inserting system automatically switches to a second feeder when the first feeder is empty and vice versa. In the mean time the first feeder can be refilled, so the inserting system can keep running without having to stop for refilling the feeders.
Feeder tray	Part of the feeder that contains the stack of documents.
Insert	<ul style="list-style-type: none"> • An insert is the action of inserting a document set into an envelope. • For native English speaking customers an insert is also a short, not to be folded document, usually an enclosure.
Inserter	An inserter is the module where the document set is inserted into the envelope, the envelope is closed and if necessary sealed.
Inserting system	The system of all the modules that cooperate to perform the inserting function (accumulate document set, fold and insert) and have a single point of control.
Job	<p>A job is an actually produced collection of mail sets based on a certain job definition at a certain point in time for a specific purpose. It consists of:</p> <ul style="list-style-type: none"> • The job definition used for the production • Information about the batch size
Job counter	The counter that registers the number of mail sets that is produced as part of a specific job.
Linking	See feeder linking.
Multifeed	The feature of an inserting system in which more than one sheet is taken from a feeder.
Operator	The person operating an inserting system.
Service engineer	Technical engineer whose task it is to resolve problems with systems in the field. Besides dealing with problems, service engineers are also responsible for preventive maintenance.
Supervisor	Person who is responsible for the technical state of the system. Normally a supervisor has access to programming functions, which are restricted for standard users.

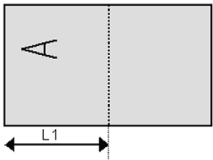
Term	Description
Test run	<p>A test run is intended to validate the settings of the inserting system:</p> <ul style="list-style-type: none"> • Inspect and adjust the stop position of the envelope. • Check the fold settings for one set. • Check whether the address is correctly positioned behind the envelope window.
Tray	<p>Contains a stack of paper for a printer or inserter. This paper is supplied to the system for further processing.</p>
V-fold	<p>A V-fold implies the document set is folded once. The fold position is adjustable. This fold is illustrated in the picture below:</p> <div style="display: flex; justify-content: space-around; align-items: center;"> <div style="text-align: center;">  <p>sideview</p> </div> <div style="text-align: center;">  </div> </div> <p>Synonym: single fold.</p>

EC DECLARATION OF CONFORMITY FOR ELECTRICAL PRODUCTS

(According to Annex III B of the Low Voltage Directive)

Manufacturer: Neopost Technologies BV
 Address: De Tijen 3, 9201 BX Drachten
 The Netherlands,

herewith declares that the:

4148353A,

- which this declaration refers to, is in accordance with:
the conditions of the Low Voltage Directive 2006/95/EC
- and the following Directive:
EMC Directive 2004/108/EC
- and is in conformity with the following harmonised standard(s) or other such specifications:

- | | |
|---|--------------------------------|
| EN 60950-1 (2006) | EN 61000-4-3 (1995) |
| EN 55022 (2006), A1 (2007) | EN 61000-4-4 (1995) |
| EN 55024 (1998), A1 (2001), A2 (2003) | EN 61000-4-5 (1995) |
| EN 61000-3-2 (2006) | EN 61000-4-6 (1996) |
| EN 61000-3-3 (2002), T:(1995), A1(2001), A2(2005) | EN 61000-4-11 (1994), T:(2005) |
| EN 61000-4-2 (1995), A1(1998), A2(2001) | |

The Netherlands, Drachten, 01-08-2011

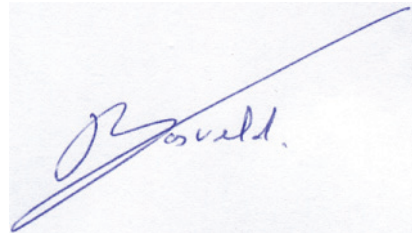

F. Bosveld
 Managing Director

This is a class A product. In a domestic environment this product may cause radio interference in which case the user may be required to take adequate measures.

Note: this equipment has been tested and found to comply with the limits for class A digital device, pursuant to Part 15 of the FCC Rules. These limits are designed to provide reasonable protection against harmful interference when the equipment is operated in a commercial environment. This equipment generates, uses, and can radiate radio frequency energy and, if not installed and used in accordance with this instruction manual, may cause harmful interference to radio communications. Operation of this equipment in a residential area is likely to cause harmful interference in which case the user will be required to correct the interference at his own expense.

Index

A

address carrier 30
address position 26, 30

B

brush replacement 19
business reply envelope 30
button 8

C

catch tray 7, 11
cleaning 19
control panel 7, 8
counter 9
current job menu 9

D

daily mail 30
DFC 6, 10
dimensions 28
display
 see touch screen
document 30
 feeder 7
 specifications 28
document set 30
document stoppage
 see stoppage
double feed control 6, 10, 30
double feeding envelopes 24
double parallel fold 31

E

envelope 31
 catch tray 11
 feed 14
 insert position 26
 load 14
 specifications 29
envelope hopper
 side guides 14
error messages 20

F

face down
 leading 31
 trailing 31
face up

 leading 31
 trailing 31
feed
 document 13
 envelope 14
feeder 5, 31
 load 13
 side guides 13
feeder 3
 load 14
 side guides 13
feeder linking 17, 31
feeder tray 31
feeding process 5
fill sealing liquid reservoir 15
fold
 double parallel 31
 letter 32
 single 32
folding area 6
folding process 5

H

home menu 9

I

insert 31
insert position 26
insert specifications 29
inserter 31
inserting process 5

J

job 32
 choose 15, 18
 counter 32
 create 17
 delete 18
 description 9
 edit 18
 information 9
 job menu 10
 new 17
 start 15
job list 9
job selection menu 9

L

letter fold 32
loading documents 13
loading envelopes 14

M

maintenance 19
menu 10
menu button 9
moistening position 26
multifeed 32

N

noise level 28

O

operating controls 7
operating instructions 11

P

paper quality 28
paper size 28
power consumption 28
power inlet 7
power switch 7
process overview 5

R

reservoir
 fill 15
run a job 15

S

safety 2
sealing liquid reservoir 7
sealing position 26
select a job 15
single fold 32
software
 see user interface
speed 28
standby button 8
start button 8
starting the job 15
stop button 8
stop the system 16
stoppage
 document feeders 20
 document path 21
 envelope hopper 22
 feeder 3 21
 inserting area 25
supervisor menu 10

T

technical specifications
 inserter 28
test run 33
touch screen 8
tray 33
troubleshooting 22

U

user interface description 8