



User Manual





MediaVise[®]





Digital Media Sanitizer



Do not attempt to operate or maintain this machine until you have read thoroughly and understand completely all operating instructions and safety rules contained in this manual.

Important Safety Highlights and Information

 	<h3>DANGER!</h3>	  
<p>STOP! Do not attempt to operate or maintain this machine until you have read thoroughly and understand completely all operating instructions and safety rules contained in this manual. Failure to comply can result in accidents involving serious personal injury, fire, electric shock, and/or irreparable damage to the machine.</p> <p>This machine weighs approximately 160 lbs. It requires at least two persons capable of lifting this weight, to lift, move or relocate the machine. The machine should only be placed on a sturdy, level surface capable of bearing this weight plus any other objects or forces that might be placed on the surface.</p> <p>This machine generates up to 40,000 pounds per square inch of crushing force that could cause serious bodily harm. NEVER repeat NEVER attempt to bypass the safety features of the MediaVise. Never insert body parts, extraneous tools, or any other objects in the machine, except as provided in this manual. Never attempt to open this machine, unless you are an authorized, qualified service professional.</p> <p>This machine is a potential source of electric shock if it is not properly set up and operated. Do not allow the machine to get wet, including exposure to moisture, rain, snow, or any forms of liquids such as beverages.</p> <p>This machine must only be plugged into a properly grounded outlet that can supply the power needed to safely run the machine. Failure to do so may present electrical and/or fire hazards.</p>		

 	<h3>CAUTION!</h3>	  
<p>This machine should ONLY be opened or serviced by qualified service personnel.</p> <p>When operating or servicing this machine, or if you are an observing bystander, you must wear the appropriate personal protective equipment (eye and/or hand protection) recommended in this manual.</p> <p>Safe operation of this machine requires that you read and understand this user manual and all labels affixed to the machine.</p> <p>You should keep this user manual handy, and review it frequently for continued safe operation. It must be made available to anyone who is authorized to use the machine.</p>		

	<h3>ATTENTION!</h3>
<p>The information and specifications included in this manual were those in effect at the time of publication. Notwithstanding, Phiston Technologies, Inc. (also referred to herein as Phiston), reserves the right to discontinue or change specifications or design at any time without notice and without incurring any obligation whatsoever, provided such changes are with the intent of improving the safety, operation and functionality of the machine.</p>	

Thank You

Dear MediaVise Owner,



Congratulations and thank you for selecting Phiston Technologies, Inc.'s state of the art **MediaVise Digital Media Sanitizer** for your data destruction needs!

Your MediaVise has been engineered and manufactured to Phiston's high standards for quality, dependability, ease of operation, and safety, and to meet the rigorous testing, regulatory and certification standards required in the industry. This user manual is your guide and first step toward what we are confident will be years of rugged, reliable, trouble-free performance. And, you have the confidence of knowing that our products are backed by first class engineering and technical support teams that stand ready to assist you in any way we can.

Your User Manual

We would like to help you to get the best possible results from your MediaVise, and to operate it safely. We therefore urge you to take the time to review this user manual completely, and familiarize yourself thoroughly with the operational, maintenance and safety guidelines provided BEFORE attempting to set up or operate your MediaVise. Pay close attention to the rules for safe operation, warnings, and cautions. If you use your machine properly and only for the purpose for which it is intended, you will enjoy years of safe, reliable service.

Warning Symbols

As you read this manual, please be alert to sections preceded by notice and warning symbols such as  and . These symbols are intended to direct your attention to information that is important, and in some cases critical, to the safe, effective, and reliable operation of your MediaVise.

Warranty

Please familiarize yourself with the warranty policy that covers your MediaVise to fully understand the coverage provided, any limitations, as well as your responsibilities as an owner in ensuring that your MediaVise does not fall out of warranty. Pay attention to things that an owner should NOT do so as not to void the warranty.

Scheduled Maintenance

When your MediaVise needs scheduled maintenance, please keep in mind that your dealer is plugged in to a network of service personnel who are qualified and authorized to service your machine. Staff at your dealership will be pleased to answer any questions or concerns you may have in this regard.

Thank you for entrusting us with your data destruction needs.

Sincerely,

Phiston Technologies, Inc.

1 A Few Words About Safety







Your safety and the safety of others are a paramount concern, and using this machine safely is an important responsibility. Do not attempt to operate or maintain this machine until you have read thoroughly and understand completely all operating instructions and safety rules contained in this manual. Failure to comply can result in accidents involving serious personal injury, fire, electric shock, and/or irreparable damage to the machine, **and will void your warranty.**

Some safety instructions apply to more than one section of this manual and may be repeated for ease of reference or to emphasize importance.

1.1 Key Safety Symbols

The following safety symbols are used throughout this manual, and in some instances on the machine, to attract your attention to possible dangers, or specific actions that need to be taken. The safety symbols, and the explanations with them, deserve your careful attention and understanding. They do not by themselves eliminate any danger. The instructions or warnings they give should not be substitutes for proper accident prevention protocols and common sense.

	DANGER: This symbol highlights hazardous situations that could arise and would result in serious bodily injury, death or extensive property damage if warnings are ignored and proper safety precautions are not taken.
	WARNING: This symbol alerts users to specific actions that must be taken to prevent possible bodily injury, and/or irreparable property and equipment damage if instructions are not followed.
	CAUTION: This symbol alerts users to follow instructions to prevent bodily injury or damage to property or equipment.
	REMINDER: This symbol directs users' attention to important information, instructions, or actions that need to be taken.

The following may also be used to indicate specific risks, hazards or protective measures that should be taken.









	Fire Hazard		Explosion Hazard
	Electrical Shock Hazard		Entanglement hazard. Keep hands, loose clothing, and long hair away from moving parts.
	Sharp Object Hazard		Eye Protection Required
	Heavy Object – Minimum 2 Person Lift Required		Hand Protection Required

Table of Contents

1	A FEW WORDS ABOUT SAFETY	3
1.1	KEY SAFETY SYMBOLS	3
2	ELECTRICAL SAFETY INSTRUCTIONS	5
2.1	GROUNDING	5
2.2	WHY IS GROUNDING NECESSARY?	5
2.3	USE OF AN EXTENSION CORD OR POWER STRIP	5
2.4	OTHER ELECTRICAL SAFETY GUIDELINES	6
3	GENERAL AND PERSONAL SAFETY INSTRUCTIONS	6
4	DESCRIPTION AND SPECIFICATIONS	7
4.1	GUARANTEED TO SANITIZE HARD DRIVES	7
4.2	OTHER MEDIA THAT CAN BE CRUSHED BY THE MEDIAVISE	7
4.3	SPECIFICATIONS	8
4.4	MEDIAVISE FRONT VIEW DIAGRAM	9
4.5	MEDIAVISE REAR VIEW DIAGRAM	9
5	PACKING LIST AND UNPACKING INSTRUCTIONS	10
5.1	PACKING LIST	10
5.2	UNPACKING INSTRUCTIONS	11
5.3	INSTALLATION INSTRUCTIONS	12
5.3.1	<i>Inspect Your MediaVise</i>	12
5.3.2	<i>Where to Install Your MediaVise</i>	12
5.3.3	<i>Connecting Your MediaVise</i>	12
6	OPERATING INSTRUCTIONS	13
7	DESTROYING HARD DRIVES AND OTHER MEDIA	14
7.1	FEEDING COMPUTER HARD DRIVES AND OTHER MEDIA INTO THE MEDIAVISE	14
7.1.1	<i>Hard Drives</i>	14
7.1.2	<i>Cell Phones and Other Media</i>	14
8	CANCELING/REVERSING A CRUSH CYCLE	15
8.1	METHOD 1: REVERSE CYCLE	15
8.2	METHOD 2: POWER OFF	15
9	EJECTING STUCK DEBRIS FROM THE CRUSHING CAVITY	15
10	MAINTENANCE & SERVICE	16
11	TROUBLESHOOTING	17
12	WARRANTY	18
13	CUSTOMER SERVICE	18

2 Electrical Safety Instructions

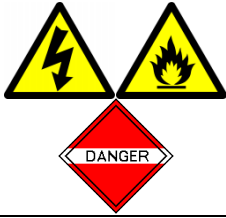

Your MediaVise has been designed and engineered with safety features that allow it to be operated safely. Ignoring or circumventing safety procedures and mechanisms are the leading cause of electrical hazards in the workplace. To reduce the risk of electric shock, fire, injury, and/or damage to your MediaVise, please follow these safety instructions.

2.1 Grounding

For your protection, your MediaVise is equipped with a power cord with a grounded, 120 volt, NEMA 5-15 three-prong electrical plug. It should only be plugged into a matching 120 volt outlet that is properly installed and grounded in accordance with all local codes and ordinances, and able to supply the power required to run the machine. Under no circumstances should the grounding prong be removed or modified in any way that would defeat this safety mechanism. In addition, the power cord that comes with your MediaVise must not be replaced with one that does not provide grounding protection.

2.2 Why is grounding necessary?

If an electrical connector inside the machine were to come loose, or if a liquid were accidentally spilled and came in contact with the electrical circuits inside the machine, the body or frame of the MediaVise could become electrically charged and present an electrocution hazard. To safeguard against this condition, the body and frame of the MediaVise are grounded so as to provide a low resistance pathway to redirect electricity away from any person who may touch the machine.

2.3 Use of an Extension Cord or Power Strip

The use of extension cords (including power strips) will inherently result in a voltage drop and loss of power delivered to the machine. Low voltage may cause the motor in the machine to struggle, stall, overheat and even burn out. Furthermore, an extension cord that is not adequately rated to supply power to the MediaVise can quickly overheat and start a fire. As far as possible, the use of extension cords for power equipment should be avoided or minimized.

If an extension cord must be used, voltage and power losses (and fire risk) can be minimized by using a heavy duty cord designed for power equipment, and keeping its length as short as possible. Use only 3-conductor extension cords that have a 3-prong grounded plug at one end, and a grounded receptacle at the other end in to which the MediaVise is plugged.

The maximum current that the MediaVise draws is 13 amps at 120 volts. To determine the minimum American Wire Gauge (AWG) size for the length of the extension cord needed for your application, please refer to an AWG Rating Chart for Extension Cords, or consult a qualified Electrician.

As a temporary measure, you may use a 12 AWG (or heavier duty) grounded extension cord for distances up to 25 feet. Bear in mind that an extension cord should never be used as a permanent means to connect your MediaVise, but only until the machine can be relocated closer to a wall receptacle, or until a new receptacle can be installed closer to the machine.

2.4 Other Electrical Safety Guidelines

Periodically check power cords for any signs of overheating. If the plugs, receptacles or power cords being used with your MediaVise feel hot to the touch, immediately turn off the machine, disconnect from the wall receptacle, and contact a qualified electrician to determine the cause of overheating.

Always take appropriate steps to ensure that power cords and/or extension cords do not present a trip or fall hazard.

Replace damaged or frayed cords immediately. Damaged cords increase the risk of electrical shock and fire.

This machine is a potential source of electric shock if it is not properly set up and operated. Do not allow the machine to get wet, including exposure to moisture, rain, snow, or any forms of liquids such as beverages.

It is good practice to turn off all power switches before plugging or unplugging the machine. In particular, make sure that the power switch on the machine is in the 'OFF' position before plugging it into a receptacle. This will prevent accidental starting.

When unplugging an electrical power cord, do not pull on the cord; grasp firmly and pull on the plug.

3 General and Personal Safety Instructions



Failure to follow the instructions listed below may result in electrical shock, fire, and/or serious personal injury.

1. Know how to quickly stop the machine in case of an emergency using the power switch on the front panel of the machine, or unplugging the power cord from the rear of the machine or from the wall outlet.
2. Do not use the machine if the 'ON/OFF' switch is not working. Operating a machine that cannot be controlled by you is dangerous and must be repaired before use.
3. Keep your work area clear and well lit. Cluttered work surfaces and dark areas invite accidents.
4. Do not operate the machine in an unsafe environment such as those containing explosive atmospheres, flammable liquids, gases and/or dust.
5. Do not operate the machine while under the influence of alcohol, drugs, and/or medications that can affect your motor skills. Do not operate the machine while drowsy, tired and/or distracted.
6. Keep people not involved with the work area, especially children, away from the work area while operating a machine.
7. Dress appropriately. Do not wear loose fitting clothing or jewelry. Keep long hair in place and contained. Keep clothing, hair and other body parts away from moving parts of the machine. Loose clothing, jewelry and hair can become snagged in moving parts.
8. Remove any tools, adjusting instruments or keys from the machine before turning it on. Extraneous objects left attached to a rotating part could cause personal injury.
9. Always wear appropriate safety equipment such as eye protection and gloves while operating or servicing power equipment. Use appropriate dust respirators, hearing protection, hard-hat, face shield or safety shoes as dictated by the work environment.

4 Description and Specifications

The Phiston MediaVise uses the power of hydraulics in conjunction with our patented crushing plates to deliver up to 40,000 pounds of force, to effectively crush and mangle computer hard drives, rendering them unreadable. The destruction cycle takes about 30 seconds, after which the sanitized hard drive is ejected into a debris collection bin.

4.1 Guaranteed to Sanitize Hard Drives

The Phiston MediaVise Digital Media Sanitizer is guaranteed to destroy and sanitize 2.5" and 3.5" computer hard drives. It is designed to exceed U.S. Department of Defense's National Security Agency (NSA) specifications for data destruction.



NOTE: The Maximum Media Size that the MediaVise will accept is 5.75" x 1.25" x 4" (H x L x W).

NOTE: In order to fulfill the Department of Defense Data Destruction Guidelines, all media placed in the MediaVise must first be passed through a magnetic degausser to remove any remnant magnetic data.

4.2 Other Media that can be Crushed by the MediaVise

The MediaVise will also crush and render unusable other electronic data storage devices that may contain sensitive or personally identifiable information, such as cell phones, personal digital assistants (PDAs), solid state storage media, GPS devices, and small circuit boards. However, data destruction to NSA specifications is NOT guaranteed.



WARNING: Do not place magnetic tapes or other thermo-plastic devices in the MediaVise as they could melt under extreme pressure and foul the crushing chamber of the machine.



DANGER: Explosion Hazard - Remove all batteries from any device (such as cell phones) **before** they are put in the MediaVise. Failure to do so could result in a dangerous explosion. If you are unsure whether a device contains a battery, **DO NOT** put it in the MediaVise.

4.3 Specifications

Actual Weight	160 lbs.
Product Dimensions	25" x 19" x 12" (H x L x W)
Shipping Weight	185 lbs.
Shipping Dimensions	30" x 22" x 15" (H x L x W)
Voltage	120 Volts A.C. \pm 10%, 60Hz
Maximum Current	13 Amps @ 120V
Cord Specifications	6 Feet @ 15Amps
Maximum Media Size	5.75" x 1.25" x 4" (H x L x W)
Full Cycle Time	30 seconds
Operating Temperature	40-100 °F

4.4 MediaVise Front View Diagram

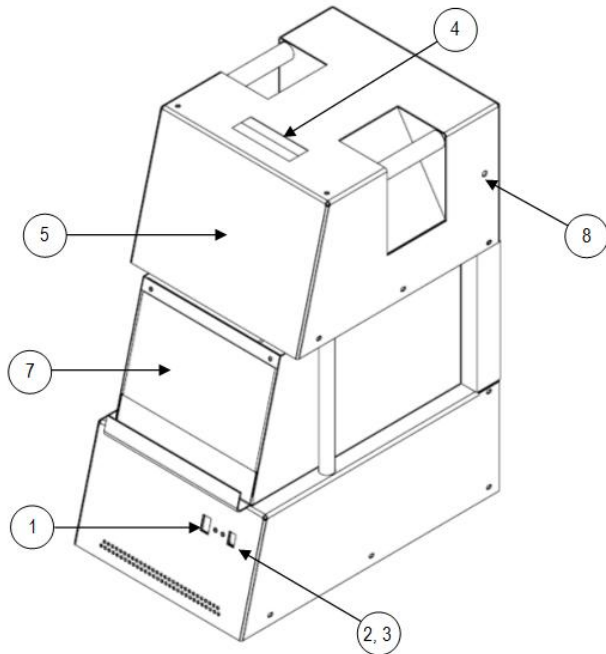

4.5 MediaVise Rear View Diagram

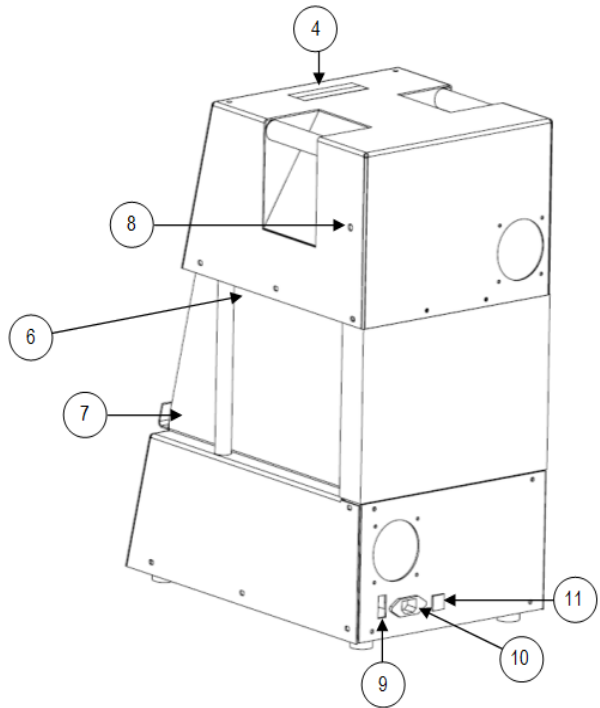

1. Power Switch
2. Crush button if pressed downwards
3. Reverse button if pressed upwards
4. Feed Doors
5. Crushing Cavity (located below the Feed Doors)
6. Drop Door (located below the Crushing Cavity, above the Collection Drawer)
7. Collection Drawer
8. Manual Unjam Port
9. Power Breaker
10. Power Receptacle
11. Fuse

5 Packing List and Unpacking Instructions

Careful attention has been paid to packaging your MediaVise to minimize any risk of damage during shipping. Your package and its contents will be insured against damage or loss; however, Phiston's and the shipping company's responsibilities for safe delivery ends the minute you take possession of your shipment. The following alert and instruction will be sent to you via email to ensure that you take the necessary actions when your shipment is delivered.



ATTENTION: Before accepting your MediaVise package, inspect the shipment for any signs of damage, improper handling and/or tampering. Note the orientation in which the unit was delivered. The shipment should be delivered in the upright position.

If there is significant damage to the crating or packaging of your shipment, decline delivery and immediately contact Phiston Technologies.

If the shipment appears to have been mishandled or tampered with in any way, DO NOT sign for or accept delivery of the shipment until you have had an opportunity to open and inspect your shipment. If there is damage to the contents of your shipment, or if any parts are missing, decline delivery and immediately contact Phiston Technologies.

5.1 Packing List

When you receive your MediaVise shipment, a copy of the Packing List will be included with the shipping documents as a means of verifying the package contents. It also serves to inform all parties, including transport agencies, government authorities, and customers, about the contents of the package.

Your package will contain the following:

- ✓ Phiston MediaVise Digital Media Sanitizer
- ✓ Phiston MediaVise Digital Media Sanitizer User Manual
- ✓ Phiston MediaVise Digital Media Sanitizer Limited Warranty
- ✓ 6 ft. Power Cable (rated for 15 A @ 120 V)
- ✓ 3/16" Hex Key (manual unjamming tool)



ATTENTION: If after unpacking your MediaVise you discover that any of the above items is missing or damaged, immediately contact your dealer or Phiston Technologies.

5.2 Unpacking Instructions



CAUTION: This machine weighs approximately 160 lbs and its shipping weight is approximately 185 lbs. This machine cannot and should not be moved by one person. It requires **at least** two persons capable of lifting this weight, to lift, move or relocate the machine.



The machine should only be placed on a sturdy, level surface capable of bearing this weight plus any other objects or forces that might be placed on the surface.

Failure to observe these safety precautions could cause serious bodily harm to you and/or others in the work area, as well as property and equipment damage.

After the shipment has been inspected and accepted, use a screwdriver to remove the screws from the top and front of the crate. Remove the top and front panels. Remove the protective foam to expose the MediaVise.



ATTENTION: Please save all crating, packaging and insulation materials in case the unit has to be returned or re-shipped.

With one capable person standing on each side of the MediaVise, use the handles on the top of the unit to lift and move it out of the crate.

The machine should only be placed on a sturdy, level surface capable of bearing its weight plus any other objects or forces that might be placed on the surface. For the MediaVise alone, we recommend a table, desk or other sturdy surface capable of safely supporting at least 200 lbs. on a continuous basis.

In case the MediaVise must be repacked for shipping, carefully place the unit back into the crate, and replace the protective foam around the unit. Close the crate by replacing the front and top panels and securely fastening them with screws.

5.3 Installation Instructions

5.3.1 Inspect Your MediaVise

Your MediaVise was thoroughly inspected and tested before leaving our factory.

Before Installing the MediaVise, inspect the unit for any parts that might have been damaged during shipping. If there are any damaged or loose parts, or if hydraulic fluid is leaking from the machine, please immediately contact your dealer or Phiston Technologies Customer Service. For more information, refer to section 13, "Customer Service," on page 18.

5.3.2 Where to Install Your MediaVise

After the inspection is completed, place the MediaVise in a location where it will have a minimum clearance of 3" in the back. No objects should obstruct the airflow at the front or the back of the unit.

Your MediaVise weighs approximately 160 lbs. It should only be placed on a sturdy, level surface capable of bearing this weight plus any other objects or forces that might be placed on the surface. For the MediaVise alone, we recommend a table, desk or other sturdy surface capable of safely supporting at least 200 lbs. on a continuous basis.

Locate your MediaVise close to a grounded 120 Volt NEMA 5-15 outlet capable of delivering at least 15 Amps. The maximum current required by the MediaVise is 13 Amps. Ensure that there are no other loads on the same circuit that would cause an overload situation when the MediaVise is running, and trip the circuit breaker.

5.3.3 Connecting Your MediaVise



STOP! Do not attempt to connect your MediaVise machine until you have read thoroughly and understand completely all operating instructions and safety rules contained in this manual.

Before plugging your MediaVise into an electrical outlet, make sure that the power ON/OFF switch on the front panel of the unit is in the OFF position.

Failure to comply can result in accidents involving serious personal injury, fire, electric shock, and/or irreparable damage to the machine.

After you have taken the above precautions, connect the power cord that was supplied with your MediaVise to the power receptacle at the rear of the machine, and plug the other end into the power outlet.

6 Operating Instructions

Place the power breaker in the back of the unit to the “Reset” position in order to turn ON the MediaVise. The red power breaker light will illuminate when the MediaVise is ON. Flip the power switch in the control panel to the “On” position in order to READY the MediaVise for operation. The green power light will illuminate when the MediaVise is READY for operation. At this time it is safe to push your media through the feed doors on the top of the device. Insert your media as is directed in section 7, “Destroying Hard Drives and Other Media,” on page 14.



WARNING: Do not place magnetic tapes or other thermo-plastic devices in the MediaVise as they could melt under extreme pressure and foul the crushing chamber of the machine.



DANGER: Explosion Hazard - Remove all batteries from any device (such as cell phones) *before* they are put in the MediaVise. Failure to do so could result in a dangerous explosion. If you are unsure whether a device contains a battery, DO NOT put it in the MediaVise.

Once your media is inserted, begin the crush cycle by pressing the “Crush” button located on the bottom front of the machine. The feed doors will lock during the crush cycle in order to prevent user injuries. Once the crush cycle ends, the drop door will open and release your destroyed media into the collection drawer.

It is normal to hear cracking and popping noises while the storage device is being crushed. This noise is indicative of your media’s destruction and is to be expected.



WARNING: Do not place your hand or fingers anywhere inside the MediaVise for any reason! Do not attempt to place anything in the MediaVise while the crush cycle is taking place. If you need to cancel a crush cycle immediately, turn off the power or perform a reverse cycle as directed in section 8, “Canceling/Reversing a Crush Cycle,” on page 15.

The maximum amount of debris the collection drawer can hold is marked on the glass by the uppermost horizontal line. Empty the collection drawer when the debris reaches this line. Debris allowed to accumulate above this line could cause other media to jam and/or not fall properly after the crushing process is complete.



CAUTION: Debris from destroyed objects may have sharp edges and, as such, should be handled with care. Use the supplied collection drawer to safely dispose of destroyed devices and media. Wear leather protective gloves and eye protection to prevent injuries from sharp edged particles and/or parts, or shrapnel that could become airborne if a crushed hard drive is accidentally dropped.

NOTE: If your device or media fails to drop from the crushing cavity and into the collection drawer, see section 9, “Ejecting Stuck Debris from the Crushing Cavity,” on page 15

7 Destroying Hard Drives and Other Media

The MediaVise is designed to be an industrial level data sanitizer. Caution must always be taken when feeding hard drives and other media into the machine to be sanitized. Section 4, “Description and Specifications Ejecting Stuck Debris from the Crushing Cavity,” on page 7 describes the types of computer hard drives and other media that can be sanitized with the MediaVise.



DANGER: NEVER attempt to bypass the safety features of the MediaVise. Never insert body parts, extraneous tools, or any other objects in the machine. Do not attempt to open this machine, unless you are an authorized, qualified service professional

7.1 Feeding Computer Hard Drives and Other Media into the MediaVise

7.1.1 Hard Drives

To feed properly, place the hard drive on the feed door. With your palm placed on the top end of the hard drive, push down until the hard drive falls through the feed doors. At this time the MediaVise is ready to begin its operation.

7.1.2 Cell Phones and Other Media

For cellular phones and other media smaller than 5.75” x 1” x 4” (H x L x W), follow the same procedure used for hard drives.



CAUTION: Load only one object at a time into the MediaVise. Loading more than one device or media may overload the crushing cavity and could cause potential damage to the MediaVise and/or the operator.



WARNING: Lithium Ion batteries commonly used in cellular phones may explode during a crushing operation. Remove all batteries from devices before inserting them into the MediaVise.



CAUTION: Always use caution when loading and unloading any items into the MediaVise.

8 Canceling/Reversing a Crush Cycle

If you placed an incorrect media into the unit's crushing cavity or would like to remove the media from the crushing cavity for any reason, use the following steps to safely remove the media.

8.1 Method 1: Reverse Cycle

Press the "Crush" button and then quickly press and hold the "Reverse" button for at least 3 seconds. This will cancel the crush cycle and reverse the system, dropping your media out of the crushing cavity.

8.2 Method 2: Power Off

During the crush cycle, set the power breaker or the power switch to "Off". Turn the power back on and the MediaVise will go directly into a reverse cycle. This will cancel the crush cycle and reverse the system, dropping your media out of the crushing cavity.



NOTE: If the reverse cycle was not initiated before the crushing plates made contact with your storage device, then your storage device may have been damaged and, therefore, the functionality of your device cannot be guaranteed.

9 Ejecting Stuck Debris from the Crushing Cavity

Occasionally, after a hard drive (or other device) has been crushed in the crushing cavity of the MediaVise, debris may become lodged in the cavity and may not readily fall into the debris collection drawer at the end of a crush or reverse cycle. To eject the stuck debris, perform the procedures outlined below:

1. Turn the power switch to the "On" position to ready the MediaVise for operation.
2. Run a reverse cycle by following the steps outlined in section 8, "Canceling/Reversing a Crush Cycle," on page 15 under "Method 1." The device should drop into the collection drawer at the end of the reverse cycle.
3. If the device still has not dropped into the collection, then initiate a manual unjam procedure. Insert the 3/16" hex key (supplied with your machine) into the unjam port located on the right side of the MediaVise. Turn the hex key clockwise approximately 3 revolutions or until the hex key doesn't turn any further. By that point, the stuck device debris should fall into the debris drawer. If it does not, then repeat the process. Do not apply excessive force after the key stops turning.
4. Repeat process as necessary.



CAUTION: Turn the hex key in a clockwise direction only! Turning the hex key counterclockwise could cause the unjamming procedure to malfunction and could cause permanent damage to the manual unjam mechanism.

10 Maintenance & Service



WARNING: Never attempt to remove the protective covering of the MediaVise or attempt to work on the unit while it is operational. Machine service, mechanical and/or electrical is to be performed **only** by qualified repair personnel. Service performed by unqualified personnel may result in risk of injury or damage to property, **and will void your warranty.**

Perform a self-check routine after every 6 months in order to verify the product's functionality. In order to do a self-check routine, complete the following steps without placing any devices or media inside the MediaVise:

1. Flip the power switch to the "On" position to ready the MediaVise for operation.
2. Run the crush cycle.
3. Run the reverse cycle.
4. Perform step 3 from section 9, "Ejecting Stuck Debris from the Crushing Cavity," on page 15. Make sure the drop door returns back to its original closed position.
5. Power off the MediaVise.
6. Completely empty the collection drawer.
7. Wipe clean the collection drawer with clean a cloth or a soft brush.



NOTE: Check the MediaVise for excessive dirt before and after every use. Clean the MediaVise when necessary. To clean the MediaVise, unplug it and clean with a clean cloth. Never use flammable liquids or solvents to clean the MediaVise.



CAUTION: Debris from destroyed objects may have sharp edges and, as such, should be handled with care. Use the supplied collection drawer to safely dispose of destroyed devices and media. Wear leather protective gloves and eye protection to prevent injuries from sharp edged particles and/or parts when placing your hand inside the collection drawer, or shrapnel that could become airborne if a crushed hard drive is accidentally dropped.

NOTE: If your device or media fails to drop from the crushing cavity and into the collection drawer, see section 9, "Ejecting Stuck Debris from the Crushing Cavity," on page 15

Should you find something wrong with your machine, refer to section 11, "Troubleshooting," on page 17.

If serious issues become apparent, report them to Phiston Technologies Customer Service. If the issues cannot be resolved, you will be directed to a service representative in your area/region for servicing or repair. If none are available, Phiston will provide further instructions on how to obtain service in your area. For more information, refer to section 13, "Customer Service," on page 18.

11 Troubleshooting

#	Issue	Solution
1	The feed doors on the MediaVise will not open to allow insertion of media.	The MediaVise automatically locks the feed doors during operation. Wait until the cycle is complete to insert a new media.
2	The hard drive is stuck in the crushing cavity.	Follow the steps outlined in section 9, "Ejecting Stuck Debris from the Crushing Cavity," on page 15.
3	The hard drive only fell half way out of the crushing cavity.	Do not run a crush cycle. Hard drives that accumulate directly under the drop door may cause the crushed hard drive to drop only partially. Emptying the collection drawer will avoid this problem. Follow the steps outlined in section 9, "Ejecting Stuck Debris from the Crushing Cavity," on page 15.
4	Media inserted through the feed doors will not fully enter the crushing cavity.	The crushing cavity may still have debris or remnants of a previously destroyed media. Remove your device from the MediaVise and follow the steps outlined in section 9, "Ejecting Stuck Debris from the Crushing Cavity," on page 15.
5	The power went out mid cycle with my hard drive still in the crushing cavity.	The MediaVise will recover by performing a full reverse cycle, allowing your media to drop into the collection drawer. If the media hasn't been destroyed, place it back into the crushing cavity and rerun the crush cycle.
6	The hard drive falls right into the collection drawer after inserting it through the feed doors.	This will occur when the drop door is not fully in place, thereby preventing a hard drive from staying inside the crushing cavity. Perform a reverse cycle or follow step 3 in section 9, "Ejecting Stuck Debris from the Crushing Cavity," on page 15 until the drop door has regained its original position.
7	The MediaVise will not crush my media after running a crush cycle.	The MediaVise is likely running low on hydraulic fluid. Contact your dealer or Phiston Customer Service so that your machine can be serviced.
8	The bottom of the MediaVise is leaking oil.	This occurs when the MediaVise is placed on its side, tilted, or moved about for extended periods. Please refrain from moving the MediaVise too often as it may cause the unit to leak hydraulic fluids. If the MediaVise has leaked an excessive amount of hydraulic fluid, Contact your dealer or Phiston Customer Service so that your machine can be serviced.
9	The MediaVise is making odd noises.	The MediaVise will often produce different sounds depending on the stage of a crush or reverse cycle. A constant humming noise during a cycle will denote the MediaVise's hydraulic power and an applied 40,000 pounds of force. If a user inserts media into the unit and begins a crush cycle, cracking and popping noises may be heard. These sounds will be apparent when the user's media is being crushed and destroyed. Furthermore, the MediaVise will occasionally create a loud, buzzing noise when media is being dropped from the crushing cavity and into the collection drawer. If you feel the MediaVise is make sounds that are not normal, call Phiston Customer Service.

10	The MediaVise will not turn on.	<p>If the MediaVise does not turn on, follow these procedures:</p> <ul style="list-style-type: none"> • Check that the power breaker in the back of the MediaVise is set in the “Reset” position. • Make sure that the unit is properly plugged in. • Ensure that the fuse, located to the right of the power receptacle, has not been ejected from its seated position. If the fuse has been ejected, then the MediaVise has experienced a power surge or a short circuit. Make sure all of the switches are set to off and disconnect the power cable. Then, push the fuse back into its original position. • Check the power cable and the outlet for any defects. If you are in doubt as to the status of your outlet, consult a qualified electrician.
----	---------------------------------	---

Refer to section 13, “Customer Service,” on page 18 for any issues that cannot be resolved by following the solutions outlined in this section.

12 Warranty

Please refer to the supplied Phiston MediaVise Digital Media Sanitizer Limited Warranty document for further information on warranty for the Phiston MediaVise Digital Media Sanitizer.

13 Customer Service

To obtain service, technical support, or general information about the product and/or accessories, please:

Contact your dealer or vendor,

Or

Call Phiston Technologies Customer Service at 305-517-1744 or e-mail us at info@phiston.com.

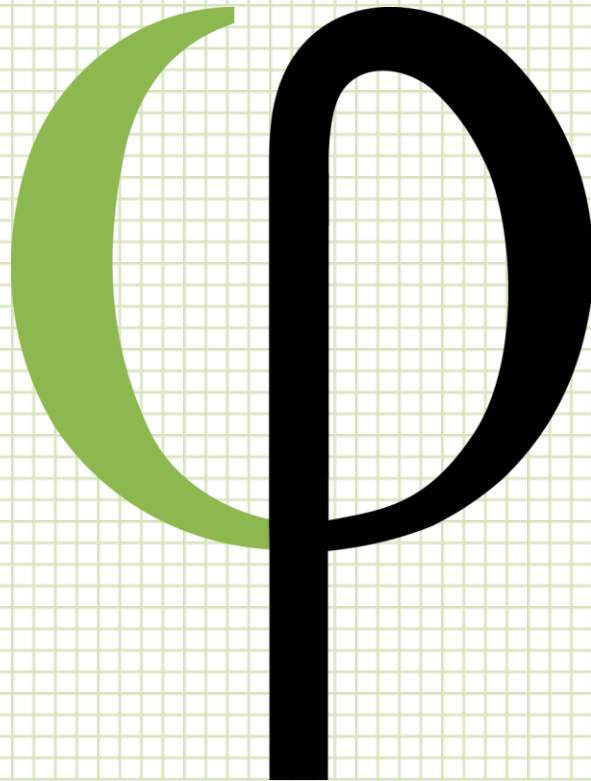

Phiston Technologies® , Inc.

3300 N.W. 112th Ave. Suite #3

Miami, FL, 33172

(305) 517-1744

www.Phiston.com



The information and specifications included in this manual were those in effect at the time of publication. Notwithstanding, Phiston Technologies, Inc. reserves the right to discontinue or change specifications or design at any time without notice and without incurring any obligation whatsoever, provided such changes are with the intent of improving the safety, operation and functionality of the machine.