

22022

PaperSAFE®

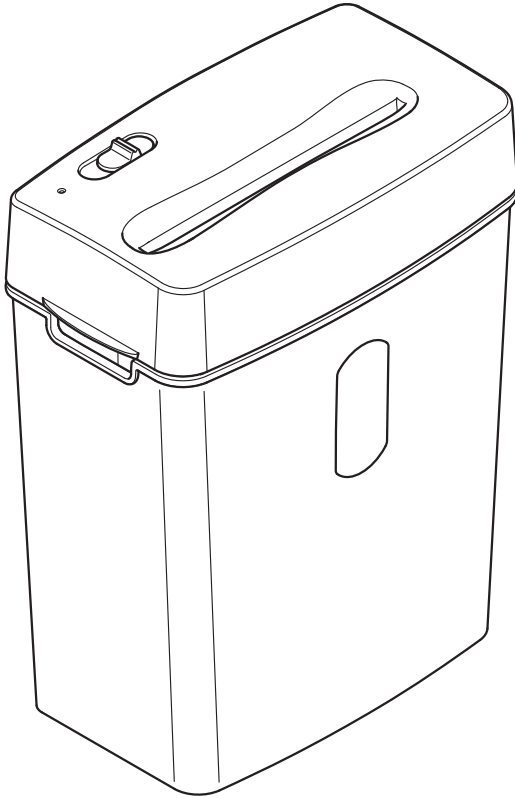



UK/US Instructions



IMPORTANT!

Read the operating and safety instructions BEFORE placing the document shredder into operation.

You must follow the instructions.

Keep the operating instructions in a safe place ready for later use.



Table of Contents

1.	Important information	6
1.4.	Scope of supply	60
1.5.	Technical specifications	60
2.	Operation	61
2.5.	Paper shredding	62
2.8.	Overload	63
2.10.	Overheated	63
2.11.	Card shredding	64
3.	Maintenance	65
3.1	Emptying shredding waste	65
3.3	Possible malfunctions	65
3.4	Cleaning the shredder	66

1.1. Intended use, warranty

The document shredder is intended to be used for shredding paper.

Depending on the model variant, a small amount of the following materials can also be shredded:

- CDs/DVDs, bank cards and credit cards (see technical data).
- The normal staples and paper clips found in paper documents (exception: security level P6 and P7 devices).

Wear, damage due to improper use or unauthorised modifications and repairs are not covered by the warranty or the guarantee.

The document shredder was designed for private use and for use in normal office environments.

1.2. Safety instructions

- Do not place the device near a source of heat.
- Store, transport and operate the device in an upright position only.
- Only use liquids and gases on the device that comply with DAHLE guidelines.
- Do not open up the device.
- Only operate the device in closed spaces, at temperatures of between 10 °C and 25 °C (50 °F to 77 °F) and at a non-condensing humidity of between 15% and 95%.
- Ensure that the building installation has short-circuit protection: max. 16 A (US max. 20 A).
- Do not operate the document shredder without inserting documents.
- The device is not intended for use by persons (including children) with restricted physical, sensory or mental capabilities or a lack of experience and knowledge, unless they are working under supervision or receive detailed instruction about how to use the device from a person who is responsible for safety.



Dispose of the document shredder properly in an environmentally friendly way at an authorised collection point. Do not dispose of any parts of the document shredder or packaging in domestic waste.

**1.3. Key to pictograms**

Important information



User information/safety instructions



WARNING



Do not use near caustic substances.



Place the device in a stable position on the floor, leaving a gap of 100 mm to the wall, ensure no heat can accumulate, engage brake mechanisms (depending on type)



Do not use near inflammable liquids or gases.



Automatic start-up



Do not expose to moisture



This document shredder is not intended to be used by children (the product is not a toy).



Do not touch the paper feed with your hands.



Do not allow items of clothing to come into contact with the paper feed.



Do not allow your hair to come into contact with the paper feed.



Keep spray cans away from the device.



Remove paper clips and staples before shredding.



Do not insert any diskettes.



Always wear safety goggles when destroying CDs/DVDs!



Disconnect the document shredder from the electrical power supply before performing maintenance work.



Technical specifications - Subject to technical modifications.



Noise level when operated without shredding documents



Intake speed



Shredded paper particles



Shredded card particles



Weight



The power plug is used to disconnect the power supply.



The mains socket must be easily accessible at all times.



How to use



Document shredder on standby



Document shredder in operation



Automatic shut-down!



The document shredder will switch off automatically to cool down if used for a long time and /or if overloaded



Maintenance instructions / troubleshooting



Container full



Possible malfunctions



Automatic switch-off when housing is open

1.



1.4.

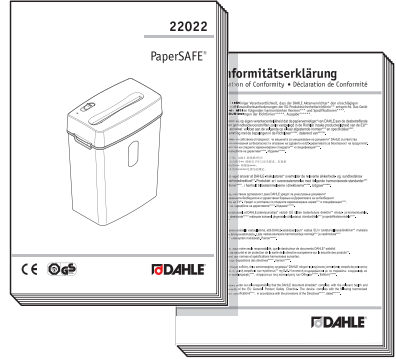
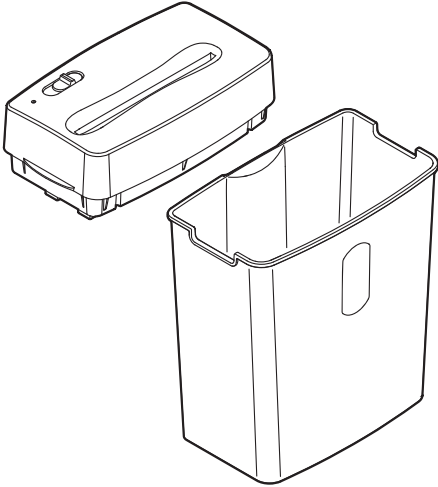

1.5.



220 - 240 V / 50 - 60 Hz
110 - 120 V / 60 Hz

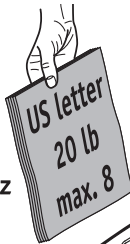

3,0m/min



DIN 66399
T-4 / E-3



DIN 66399
P-4



4,0 x 30 mm

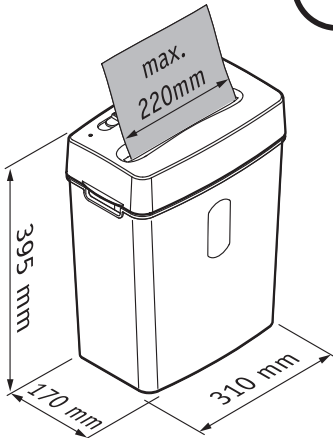

3,8 kg

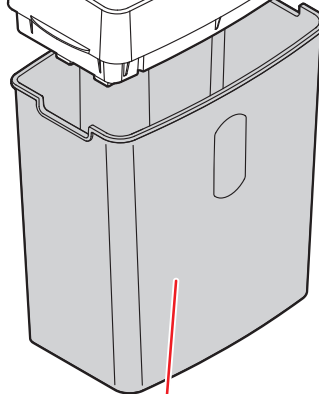

14 l



<59 dB (A)

2.



2.1.



2.2.

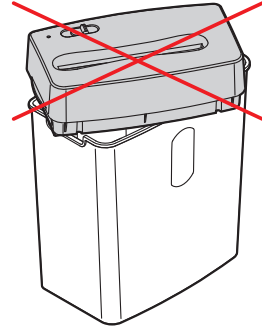
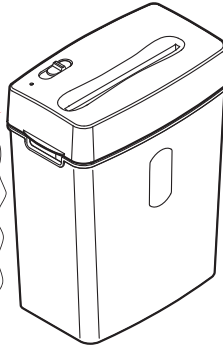

~~O.K.~~

Typ Best.-Nr.

Baujahr

Baujahr

220-240 V
50-60 Hz

110-120 V
60 Hz



2.3.



1.



2.

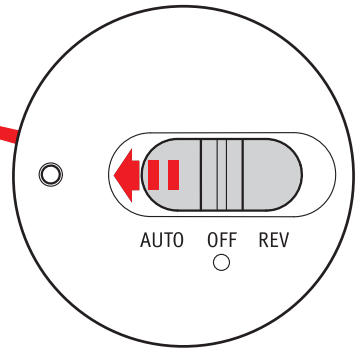
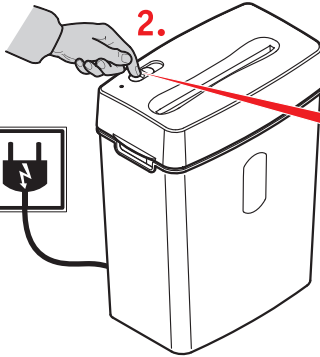

2.4.

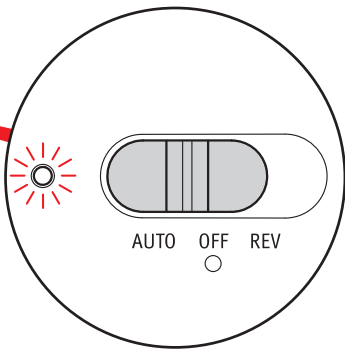
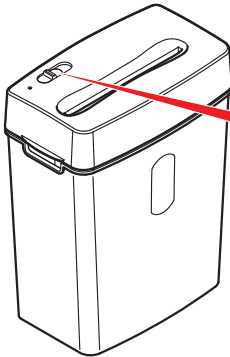

2.



2.5.



2.6.

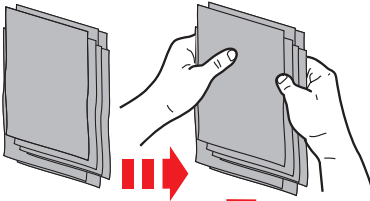

O.K.

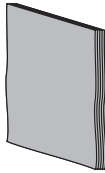

O.K.

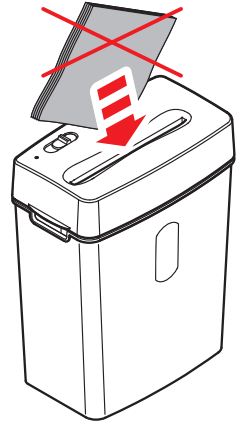

2.7.

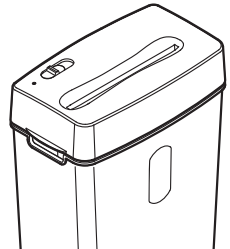
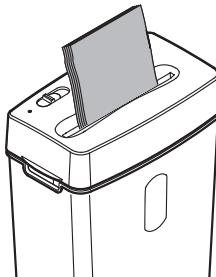
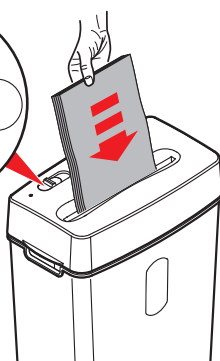
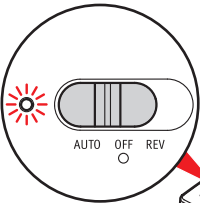

2.



2.8.



~~O.K.~~

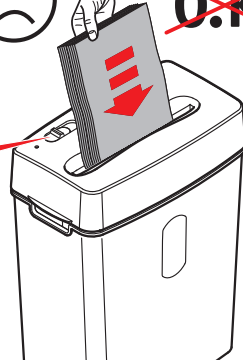
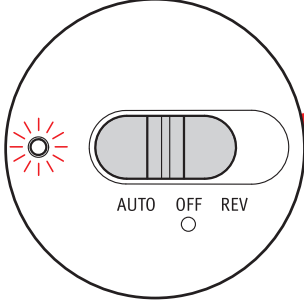

2.9.

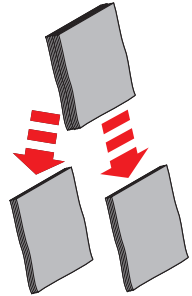
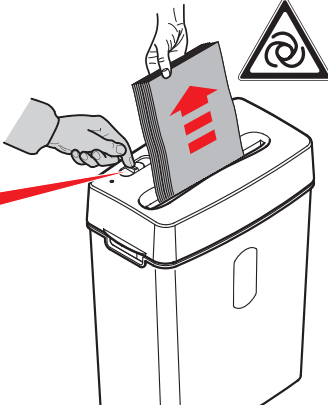
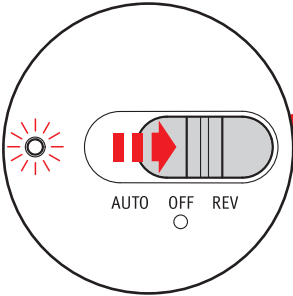

2.7.

2.10.

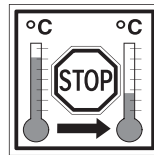

2.7.

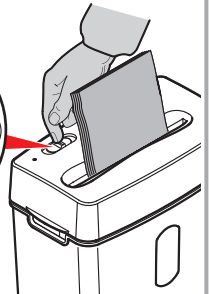
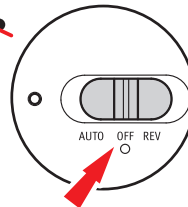
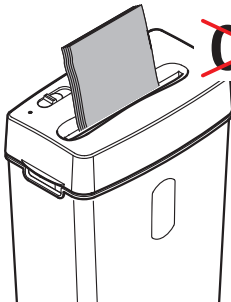
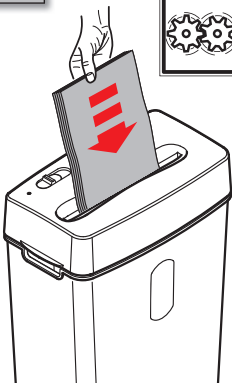

2.



2.11.



2.12.

O.K.

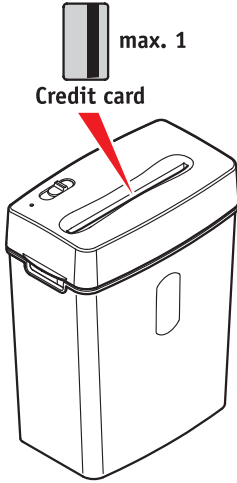

O.K.

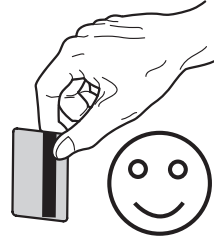

~~O.K.~~

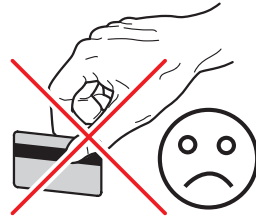

2.13.

max. 1

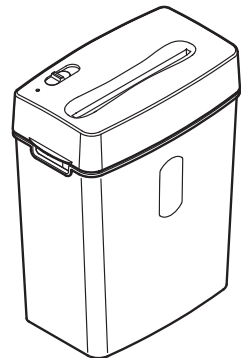
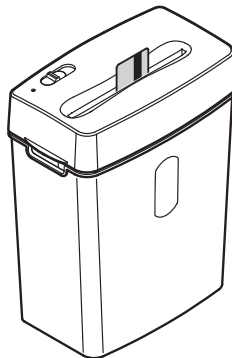
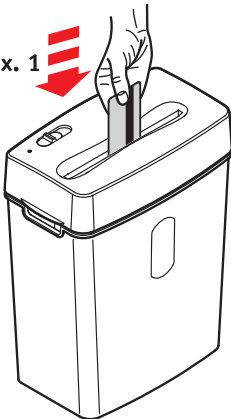

3.



DAHLE[®]

3.1.

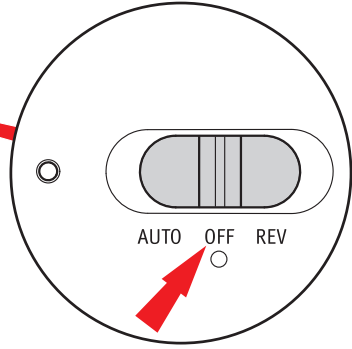
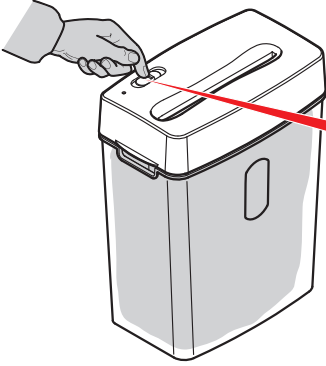

3.2.



1.



2.

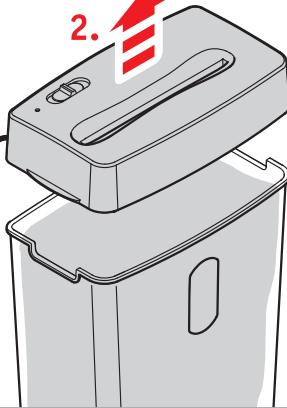

3.

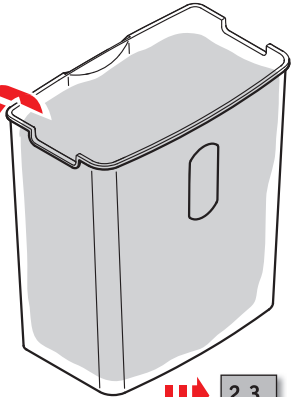
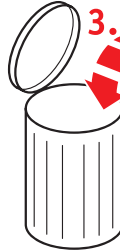

2.3.

3.3.



~~O.K.~~

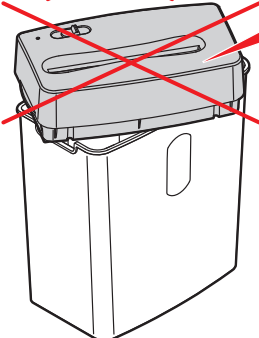

O.K.

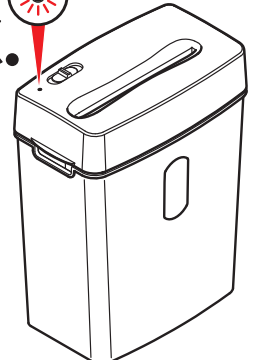

3.



3.4.



1. ↓

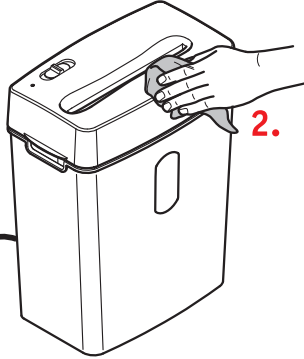

Headquarters:

Novus Dahle GmbH & Co. KG
Breslauer Straße 34-38
49808 Lingen | Germany

Service contact:

Novus Dahle GmbH & Co. KG
Nikolaus-A.-Otto-Straße 11
96472 Rödental | Germany

Tel.: +49 9563 75299-0

Fax: +49 9563 75299-333

E-Mail: info@dahle.de

Web: www.dahle.de